

## SUPPLEMENTAL / BID BULLETIN NO. 1

Title : Supply and Delivery of Various Furniture and Fixtures for DSWD Central Office

ITB No. : GOP/16-DSWD-038

Date : 10 October 2016

---

This Supplemental/ Bid Bulletin is issued to all prospective bidders announcing amendments/changes in the Bidding Documents and procurement schedule, to wit:

### I. Section VII. Technical Specifications

The following are the dimensions and sample pictures for the bidder's reference. All items are subject for End-user's approval.



**NOTE:**  
-PICTURE IS FOR REFERENCE ONLY  
-ALL DIMENSIONS ARE IN TOLERABLE VARIANCE  
OF MORE OR LESS 1 INCH / 2.5 CM.

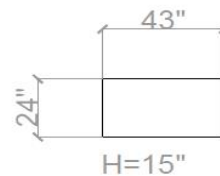
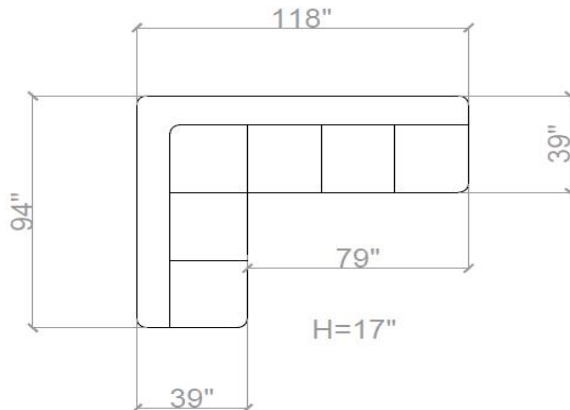

**L - SHAPE SOFA WITH WOODEN  
RECTANGULAR CENTER TABLE**



**NOTE:**  
 -PICTURE IS FOR REFERENCE ONLY  
 -ALL DIMENSIONS ARE IN TOLERABLE VARIANCE  
 OF MORE OR LESS 1 INCH / 2.5 CM.

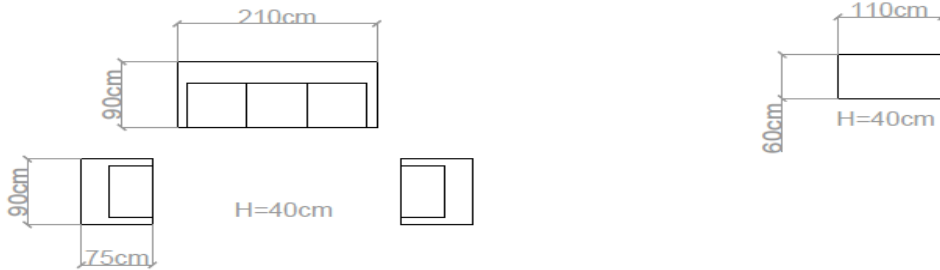

## SALA SET WITH SOLID WOOD FRAME WITH LEATHER CUSHION

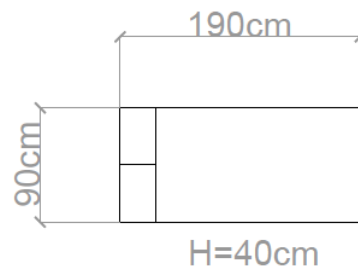

(with 36" x 75" x 6" thk foam)

**NOTE:**  
 -PICTURE IS FOR REFERENCE ONLY  
 -ALL DIMENSIONS ARE IN TOLERABLE VARIANCE  
 OF MORE OR LESS 1 INCH / 2.5 CM.

## SINGLE BED WITH FOAM

QUEEN SIZE BED FRAME

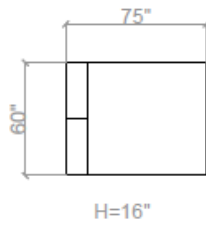

SOFA BED

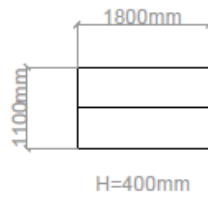

DRESSER WITH STOOL

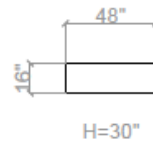

NITE TABLE

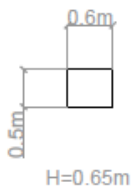

FULL VIEW MIRROR

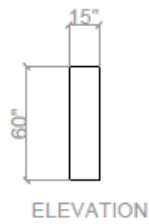

3 DOOR WARDROBE

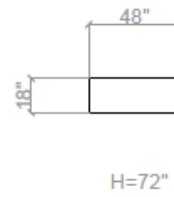

### DRESSER WITH STOOL

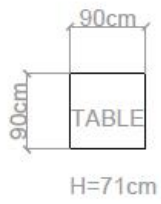

### TV RACK STAND

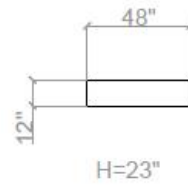

### END TABLE

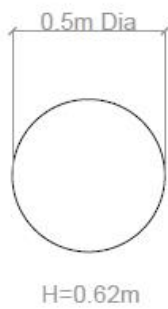

### 2 SEATER LOUNGE TABLE

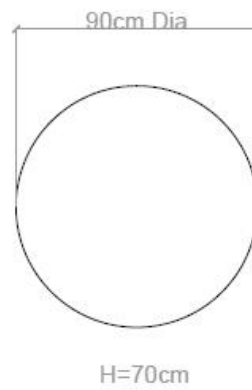



# RECEPTION DESK/COUNTER

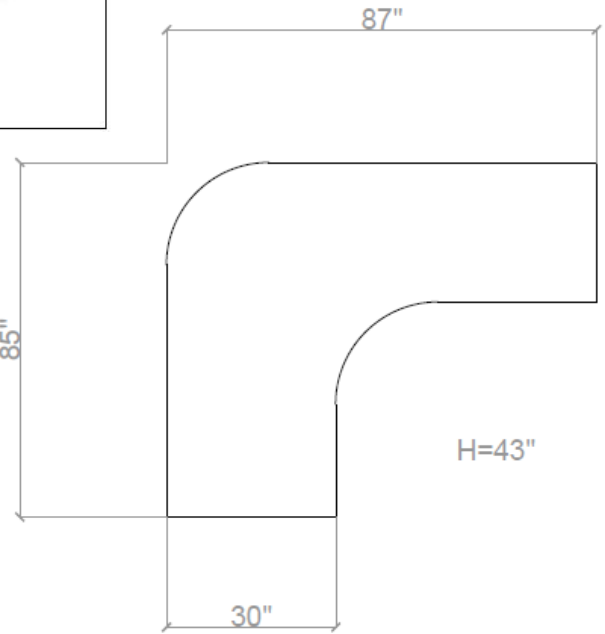

# OUTDOOR CHAIR AND TABLE (SYNTHETIC RATTAN, METAL FRAME)

90cm Diameter

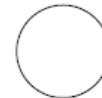

H=70cm

1 UNIT TABLE

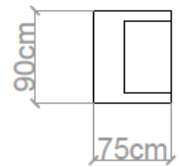

H=45cm

1 UNIT CHAIR

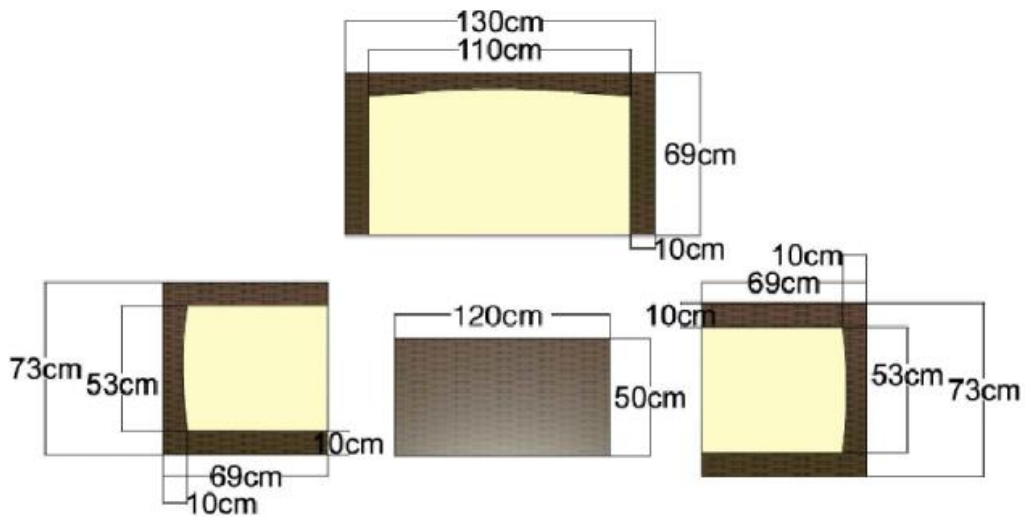

## RATTAN SOFA SET



## WALL COAT HOOK AND CLOTHES HANGER

**II. Deadline for the Submission and Receipt of Bids**

The deadline for the submission and receipt of bids is moved from 12 October 2016 to 19 October 2016 at 01:00 p.m. Bids must be delivered to the BAC Secretariat Office, Ground Floor, DSWD Central Office. **Late Bids will not be accepted.**

The Bid Opening will immediately follow after the deadline, to be held at the Knowledge Exchange Center (KEC) Library, 4<sup>th</sup> Floor, DSWD Central Office, IBP Road, Constitution Hills, Quezon City.

**III. Issuance of Bidding Documents**

The issuance of bidding documents is extended until **19 October 2016**.

This Bid Bulletin shall form part of the bidding documents.

Please be guided accordingly.

**VILMA B. CABRERA**  
Undersecretary and  
Bids and Awards Committee-I Chairperson

By:

(Original Signed)  
**CARLO FLORENDO C. CASTRO**  
Director IV and  
Bids and Awards Committee-I Vice-Chairperson

**Please accomplish this portion and send it to facsimile no. (02) 931-6139 or email at bacsec@dswd.gov.ph**

-----  
Received from DSWD, Supplemental/Bid Bulletin No. 1 for **Supply and Delivery of Various Furniture and Fixtures for DSWD Central Office** (ITB No. GOP/16-DSWD-038).

Received by : \_\_\_\_\_ Date : \_\_\_\_\_  
(Signature over Printed Name)  
Designation : \_\_\_\_\_  
Company : \_\_\_\_\_