

**Republic of the Philippines**  
**Department of Social Welfare and Development**  
IBP Road, Constitution Hills, Quezon City  
Telephone Nos. (02) 931-8101 to 07 Local 122 or 124  
Email Add: [bacsec@dswd.gov.ph](mailto:bacsec@dswd.gov.ph)



---

# BIDDING DOCUMENTS

---

**SUBSCRIPTION OF LOCAL AREA NETWORK SERVICES  
FOR DSWD CENTRAL OFFICE NEW BUILDING**

**ITB No. GOP/19-DSWD-007**  
(PR No. 2018103544)



**DECEMBER 2018**

# **PHILIPPINE BIDDING DOCUMENTS**

(As Harmonized with Development Partners)

# Procurement of **GOODS**

Government of the Republic of the Philippines

**Fifth Edition**  
**October 2016**

# TABLE OF CONTENTS

<b>SECTION I. INVITATION TO BID.....</b>	<b>3</b>
<b>SECTION II. INSTRUCTIONS TO BIDDERS .....</b>	<b>6</b>
<b>SECTION III. BID DATA SHEET .....</b>	<b>36</b>
<b>SECTION IV. GENERAL CONDITIONS OF CONTRACT .....</b>	<b>42</b>
<b>SECTION V. SPECIAL CONDITIONS OF CONTRACT .....</b>	<b>59</b>
<b>SECTION VI. SCHEDULE OF REQUIREMENTS.....</b>	<b>64</b>
<b>SECTION VII. TECHNICAL SPECIFICATIONS.....</b>	<b>66</b>
<b>SECTION VIII. BIDDING FORMS.....</b>	<b>87</b>

# ***Section I. Invitation to Bid***

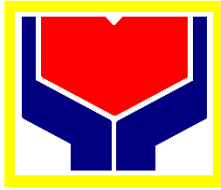

**Republic of the Philippines**  
**Department of Social Welfare and Development**  
IBP Road, Constitution Hills, Quezon City  
Telephone Nos. (02) 931-8101 to 07 Local 122 or 124  
Email: [bacsec@dswd.gov.ph](mailto:bacsec@dswd.gov.ph)

**INVITATION TO BID FOR**  
**SUBSCRIPTION OF LOCAL AREA NETWORK SERVICES**  
**FOR DSWD CENTRAL OFFICE NEW BUILDING**  
— ITB No. GOP/19-DSWD-007 —  
(PR No. 2018103544)

1. The **Department of Social Welfare and Development (DSWD)**, through the **Information and Communications Technology Management Service (ICTMS) – Miscellaneous and Other Operating Expenses (MOOE) Funds**, intends to apply the sum of **Thirteen Million Three Hundred Thirty-Two Thousand Pesos (PhP 13,332,000.00)**, being the Approved Budget for the Contract (ABC) to payments under the contract for the **Subscription of Local Area Network Services for DSWD Central Office New Building**. Bids received in excess of the ABC shall be automatically rejected at bid opening.
2. The DSWD now invites registered Philippine Government Electronic Procurement System (PhilGEPS) service providers to bid for the **Subscription of Local Area Network Services for DSWD Central Office New Building**. Delivery of Goods and Services shall be in accordance with **Section VI. Schedule of Requirements**. Bidders should have completed, **within five (5) years from the date of submission and receipt of bids**, a contract similar to the Project. The description of an eligible bidder is contained in the Bidding Documents, particularly, in Section II. Instructions to Bidders.
3. Bidding will be conducted through open competitive bidding procedures using a non-discretionary “pass/fail” criterion as specified in the 2016 Revised Implementing Rules and Regulations (IRR) of Republic Act (RA) 9184, otherwise known as the “Government Procurement Reform Act”.

Bidding is restricted to Filipino citizens/sole proprietorships, partnerships, or organizations with at least sixty percent (60%) interest or outstanding capital stock belonging to citizens of the Philippines, and to citizens or organizations of a country the laws or regulations of which grant similar rights or privileges to Filipino citizens, pursuant to RA 5183.

4. Interested bidders may obtain further information from **DSWD Bids and Awards Committee (BAC) Secretariat** and inspect the Bidding Documents at the address given below from **Monday to Friday at 8:00 a.m. to 5:00 p.m.**

5. A complete set of Bidding Documents may be purchased by interested Bidders on **11 December 2018 to 04 January 2019** from the address below and upon payment of a nonrefundable fee for the Bidding Documents in the amount of **Fifteen Thousand Pesos (PhP 15,000.00)**.

It may also be downloaded free of charge from the website of the PhilGEPS and the website of the Procuring Entity, provided that Bidders shall pay the nonrefundable fee for the Bidding Documents not later than the submission of their bids.

6. The DSWD will hold a **Pre-Bid Conference on 19 December 2018, 02:00 p.m.**, at the **Social Technology Conference Room, 3<sup>rd</sup> Floor, DSWD Central Office, IBP Road, Constitution Hills, Quezon City** which shall be open to all interested parties.
7. Bids must be delivered to the address below on or before **04 January 2019, 09:00 a.m.** All Bids must be accompanied by a bid security in any of the acceptable forms and in the amount stated in **ITB** Clause 18.

Bid opening shall be on **04 January 2019, 11:00 a.m.**, at the **Legal Service Conference Room, 4<sup>th</sup> Floor, DSWD Central Office, IBP Road, Constitution Hills, Quezon City**. Bids will be opened in the presence of the Bidders' representatives who choose to attend. Late bids shall not be accepted.

8. To facilitate the immediate implementation of the procurement of this Project, the DSWD shall proceed with the procurement activities short of award, pending the approval of the 2019 General Appropriation Act (GAA), pursuant to Section 7.6 of the 2016 Revised IRR of RA 9184, Section 19 of the General Provisions of the FY 2019 National Expenditure Program (NEP) and Department of Budget and Management (DBM) Circular Letter No. 2018-8 dated 30 July 2018.
9. The DSWD reserves the right to reject any and all bids, declare a failure of bidding, or not award the contract at any time prior to contract award in accordance with Section 41 of RA 9184 and its 2016 Revised IRR, without thereby incurring any liability to the affected bidder or bidders.
10. For further information, please refer to:

**THE CHAIRPERSON**

DSWD Bids and Awards Committee  
c/o BAC Secretariat  
Ground Floor, DSWD Central Office  
IBP Road, Constitution Hills, Quezon City  
Fax No. (02) 931-6139  
Telephone Nos. (02) 931-8101 to 07 Local 122 or 124

*(Original Signed)*  
**ATTY. AIMEE TORREFRANCA-NERI**  
*Undersecretary and*  
*Chairperson, Bids and Awards Committee*

***Section II. Instructions to Bidders***

## **TABLE OF CONTENTS**

<b>A. GENERAL .....</b>	<b>9</b>
1. Scope of Bid .....	9
2. Source of Funds .....	9
3. Corrupt, Fraudulent, Collusive, and Coercive Practices .....	9
4. Conflict of Interest .....	10
5. Eligible Bidders .....	12
6. Bidder’s Responsibilities.....	13
7. Origin of Goods.....	15
8. Subcontracts .....	15
<b>B. CONTENTS OF BIDDING DOCUMENTS .....</b>	<b>16</b>
9. Pre-Bid Conference .....	16
10. Clarification and Amendment of Bidding Documents .....	16
<b>C. PREPARATION OF BIDS .....</b>	<b>17</b>
11. Language of Bid .....	17
12. Documents Comprising the Bid: Eligibility and Technical Components .....	17
13. Documents Comprising the Bid: Financial Component .....	19
14. Alternative Bids.....	20
15. Bid Prices .....	20
16. Bid Currencies.....	22
17. Bid Validity .....	22
18. Bid Security.....	23
19. Format and Signing of Bids .....	25
20. Sealing and Marking of Bids.....	25
<b>D. SUBMISSION AND OPENING OF BIDS.....</b>	<b>26</b>
21. Deadline for Submission of Bids .....	26
22. Late Bids .....	26
23. Modification and Withdrawal of Bids.....	26
24. Opening and Preliminary Examination of Bids .....	27
<b>E. EVALUATION AND COMPARISON OF BIDS .....</b>	<b>29</b>
25. Process to be Confidential.....	29
26. Clarification of Bids .....	29
27. Domestic Preference .....	29



28.	Detailed Evaluation and Comparison of Bids .....	30
29.	Post-Qualification.....	31
30.	Reservation Clause .....	32
F.	AWARD OF CONTRACT.....	33
31.	Contract Award .....	33
32.	Signing of the Contract .....	34
33.	Performance Security .....	34
34.	Notice to Proceed .....	35
35.	Protest Mechanism.....	36

## **A. General**

### **1. Scope of Bid**

- 1.1. The Procuring Entity named in the **BDS** invites bids for the supply and delivery of the Goods as described in Section VII. Technical Specifications.
- 1.2. The name, identification, and number of lots specific to this bidding are provided in the **BDS**. The contracting strategy and basis of evaluation of lots is described in **ITB** Clause 28.

### **2. Source of Funds**

The Procuring Entity has a budget or has received funds from the Funding Source named in the **BDS**, and in the amount indicated in the **BDS**. It intends to apply part of the funds received for the Project, as defined in the **BDS**, to cover eligible payments under the contract.

### **3. Corrupt, Fraudulent, Collusive, and Coercive Practices**

- 3.1. Unless otherwise specified in the **BDS**, the Procuring Entity as well as the bidders and suppliers shall observe the highest standard of ethics during the procurement and execution of the contract. In pursuance of this policy, the Procuring Entity:
  - (a) defines, for purposes of this provision, the terms set forth below as follows:
    - (i) “corrupt practice” means behavior on the part of officials in the public or private sectors by which they improperly and unlawfully enrich themselves, others, or induce others to do so, by misusing the position in which they are placed, and includes the offering, giving, receiving, or soliciting of anything of value to influence the action of any such official in the procurement process or in contract execution; entering, on behalf of the government, into any contract or transaction manifestly and grossly disadvantageous to the same, whether or not the public officer profited or will profit thereby, and similar acts as provided in RA 3019.
    - (ii) “fraudulent practice” means a misrepresentation of facts in order to influence a procurement process or the execution of a contract to the detriment of the Procuring Entity, and includes collusive practices among Bidders (prior to or after bid submission) designed to establish bid prices at artificial, non-competitive levels and to deprive the Procuring Entity of the benefits of free and open competition.
    - (iii) “collusive practices” means a scheme or arrangement between two or more Bidders, with or without the knowledge of the

Procuring Entity, designed to establish bid prices at artificial, non-competitive levels.

- (iv) “coercive practices” means harming or threatening to harm, directly or indirectly, persons, or their property to influence their participation in a procurement process, or affect the execution of a contract;
- (v) “obstructive practice” is
  - (aa) deliberately destroying, falsifying, altering or concealing of evidence material to an administrative proceedings or investigation or making false statements to investigators in order to materially impede an administrative proceedings or investigation of the Procuring Entity or any foreign government/foreign or international financing institution into allegations of a corrupt, fraudulent, coercive or collusive practice; and/or threatening, harassing or intimidating any party to prevent it from disclosing its knowledge of matters relevant to the administrative proceedings or investigation or from pursuing such proceedings or investigation; or
  - (bb) acts intended to materially impede the exercise of the inspection and audit rights of the Procuring Entity or any foreign government/foreign or international financing institution herein.
- (b) will reject a proposal for award if it determines that the Bidder recommended for award has engaged in any of the practices mentioned in this Clause for purposes of competing for the contract.

3.2. Further, the Procuring Entity will seek to impose the maximum civil, administrative, and/or criminal penalties available under applicable laws on individuals and organizations deemed to be involved in any of the practices mentioned in **ITB** Clause 3.1(a).

3.3. Furthermore, the Funding Source and the Procuring Entity reserve the right to inspect and audit records and accounts of a bidder or supplier in the bidding for and performance of a contract themselves or through independent auditors as reflected in the **GCC** Clause 3.

#### **4. Conflict of Interest**

4.1. All Bidders found to have conflicting interests shall be disqualified to participate in the procurement at hand, without prejudice to the imposition of appropriate administrative, civil, and criminal sanctions. A Bidder may be considered to have conflicting interests with another Bidder in any of the events described in paragraphs (a) through (c) below and a general conflict of

interest in any of the circumstances set out in paragraphs (d) through (g) below:

- (a) A Bidder has controlling shareholders in common with another Bidder;
- (b) A Bidder receives or has received any direct or indirect subsidy from any other Bidder;
- (c) A Bidder has the same legal representative as that of another Bidder for purposes of this bid;
- (d) A Bidder has a relationship, directly or through third parties, that puts them in a position to have access to information about or influence on the bid of another Bidder or influence the decisions of the Procuring Entity regarding this bidding process;
- (e) A Bidder submits more than one bid in this bidding process. However, this does not limit the participation of subcontractors in more than one bid;
- (f) A Bidder who participated as a consultant in the preparation of the design or technical specifications of the Goods and related services that are the subject of the bid; or
- (g) A Bidder who lends, or temporarily seconds, its personnel to firms or organizations which are engaged in consulting services for the preparation related to procurement for or implementation of the project, if the personnel would be involved in any capacity on the same project.

4.2. In accordance with Section 47 of the IRR of RA 9184, all Bidding Documents shall be accompanied by a sworn affidavit of the Bidder that it is not related to the Head of the Procuring Entity (HoPE), members of the Bids and Awards Committee (BAC), members of the Technical Working Group (TWG), members of the BAC Secretariat, the head of the Project Management Office (PMO) or the end-user unit, and the project consultants, by consanguinity or affinity up to the third civil degree. On the part of the Bidder, this Clause shall apply to the following persons:

- (a) If the Bidder is an individual or a sole proprietorship, to the Bidder himself;
- (b) If the Bidder is a partnership, to all its officers and members;
- (c) If the Bidder is a corporation, to all its officers, directors, and controlling stockholders;
- (d) If the Bidder is a cooperative, to all its officers, directors, and controlling shareholders or members; and

- (e) If the Bidder is a joint venture (JV), the provisions of items (a), (b), (c), or (d) of this Clause shall correspondingly apply to each of the members of the said JV, as may be appropriate.

Relationship of the nature described above or failure to comply with this Clause will result in the automatic disqualification of a Bidder.

## 5. Eligible Bidders

- 5.1. Unless otherwise provided in the **BDS**, the following persons shall be eligible to participate in this bidding:
  - (a) Duly licensed Filipino citizens/sole proprietorships;
  - (b) Partnerships duly organized under the laws of the Philippines and of which at least sixty percent (60%) of the interest belongs to citizens of the Philippines;
  - (c) Corporations duly organized under the laws of the Philippines, and of which at least sixty percent (60%) of the outstanding capital stock belongs to citizens of the Philippines;
  - (d) Cooperatives duly organized under the laws of the Philippines; and
  - (e) Persons/entities forming themselves into a Joint Venture (JV), *i.e.*, a group of two (2) or more persons/entities that intend to be jointly and severally responsible or liable for a particular contract: Provided, however, that Filipino ownership or interest of the JV concerned shall be at least sixty percent (60%).
- 5.2. Foreign bidders may be eligible to participate when any of the following circumstances exist, as specified in the **BDS**:
  - (a) When a Treaty or International or Executive Agreement as provided in Section 4 of RA 9184 and its IRR allow foreign bidders to participate;
  - (b) Citizens, corporations, or associations of a country, the laws or regulations of which grant reciprocal rights or privileges to citizens, corporations, or associations of the Philippines;
  - (c) When the Goods sought to be procured are not available from local suppliers; or
  - (d) When there is a need to prevent situations that defeat competition or restrain trade.
- 5.3. Government owned or –controlled corporations (GOCCs) may be eligible to participate only if they can establish that they (a) are legally and financially autonomous, (b) operate under commercial law, and (c) are not attached agencies of the Procuring Entity.

- 5.4. Unless otherwise provided in the **BDS**, the Bidder must have completed a Single Largest Completed Contract (SLCC) similar to the Project and the value of which, adjusted, if necessary, by the Bidder to current prices using the Philippine Statistics Authority (PSA) consumer price index, must be at least equivalent to a percentage of the ABC stated in the **BDS**.

For this purpose, contracts similar to the Project shall be those described in the **BDS**, and completed within the relevant period stated in the Invitation to Bid and **ITB** Clause 12.1(a)(ii).

- 5.5. The Bidder must submit a computation of its Net Financial Contracting Capacity (NFCC), which must be at least equal to the ABC to be bid, calculated as follows:

NFCC = [(Current assets minus current liabilities) (15)] minus the value of all outstanding or uncompleted portions of the projects under ongoing contracts, including awarded contracts yet to be started, coinciding with the contract to be bid.

The values of the domestic bidder's current assets and current liabilities shall be based on the latest Audited Financial Statements submitted to the BIR.

For purposes of computing the foreign bidders' NFCC, the value of the current assets and current liabilities shall be based on their audited financial statements prepared in accordance with international financial reporting standards.

If the prospective bidder opts to submit a committed Line of Credit, it must be at least equal to ten percent (10%) of the ABC to be bid. If issued by a foreign universal or commercial bank, it shall be confirmed or authenticated by a local universal or commercial bank.

## **6. Bidder's Responsibilities**

- 6.1. The Bidder or its duly authorized representative shall submit a sworn statement in the form prescribed in Section VIII. Bidding Forms as required in **ITB** Clause 12.1(b)(iii).
- 6.2. The Bidder is responsible for the following:
- (a) Having taken steps to carefully examine all of the Bidding Documents;
  - (b) Having acknowledged all conditions, local or otherwise, affecting the implementation of the contract;
  - (c) Having made an estimate of the facilities available and needed for the contract to be bid, if any;
  - (d) Having complied with its responsibility to inquire or secure Supplemental/Bid Bulletin(s) as provided under **ITB** Clause 10.4.

- (e) Ensuring that it is not “blacklisted” or barred from bidding by the GOP or any of its agencies, offices, corporations, or LGUs, including foreign government/foreign or international financing institution whose blacklisting rules have been recognized by the GPPB;
- (f) Ensuring that each of the documents submitted in satisfaction of the bidding requirements is an authentic copy of the original, complete, and all statements and information provided therein are true and correct;
- (g) Authorizing the HoPE or its duly authorized representative/s to verify all the documents submitted;
- (h) Ensuring that the signatory is the duly authorized representative of the Bidder, and granted full power and authority to do, execute and perform any and all acts necessary and/or to represent the Bidder in the bidding, with the duly notarized Secretary’s Certificate attesting to such fact, if the Bidder is a corporation, partnership, cooperative, or joint venture;
- (i) Complying with the disclosure provision under Section 47 of RA 9184 and its IRR in relation to other provisions of RA 3019;
- (j) Complying with existing labor laws and standards, in the case of procurement of services; Moreover, bidder undertakes to:
  - (i) Ensure the entitlement of workers to wages, hours of work, safety and health and other prevailing conditions of work as established by national laws, rules and regulations; or collective bargaining agreement; or arbitration award, if and when applicable.

In case there is a finding by the Procuring Entity or the DOLE of underpayment or non-payment of workers’ wage and wage-related benefits, bidder agrees that the performance security or portion of the contract amount shall be withheld in favor of the complaining workers pursuant to appropriate provisions of Republic Act No. 9184 without prejudice to the institution of appropriate actions under the Labor Code, as amended, and other social legislations.

- (ii) Comply with occupational safety and health standards and to correct deficiencies, if any.

In case of imminent danger, injury or death of the worker, bidder undertakes to suspend contract implementation pending clearance to proceed from the DOLE Regional Office and to comply with Work Stoppage Order; and

- (iii) Inform the workers of their conditions of work, labor clauses under the contract specifying wages, hours of work and other benefits under prevailing national laws, rules and regulations; or collective bargaining agreement; or arbitration award, if and when applicable, through posting in two (2) conspicuous places in the establishment's premises; and
- (k) Ensuring that it did not give or pay, directly or indirectly, any commission, amount, fee, or any form of consideration, pecuniary or otherwise, to any person or official, personnel or representative of the government in relation to any procurement project or activity.

Failure to observe any of the above responsibilities shall be at the risk of the Bidder concerned.

- 6.3. The Bidder is expected to examine all instructions, forms, terms, and specifications in the Bidding Documents.
- 6.4. It shall be the sole responsibility of the Bidder to determine and to satisfy itself by such means as it considers necessary or desirable as to all matters pertaining to the contract to be bid, including: (a) the location and the nature of this Project; (b) climatic conditions; (c) transportation facilities; and (d) other factors that may affect the cost, duration, and execution or implementation of this Project.
- 6.5. The Procuring Entity shall not assume any responsibility regarding erroneous interpretations or conclusions by the prospective or eligible bidder out of the data furnished by the procuring entity. However, the Procuring Entity shall ensure that all information in the Bidding Documents, including bid/supplemental bid bulletin/s issued, are correct and consistent.
- 6.6. Before submitting their bids, the Bidder is deemed to have become familiar with all existing laws, decrees, ordinances, acts and regulations of the Philippines which may affect this Project in any way.
- 6.7. The Bidder shall bear all costs associated with the preparation and submission of his bid, and the Procuring Entity will in no case be responsible or liable for those costs, regardless of the conduct or outcome of the bidding process.
- 6.8. The Bidder should note that the Procuring Entity will accept bids only from those that have paid the applicable fee for the Bidding Documents at the office indicated in the Invitation to Bid.

## **7. Origin of Goods**

Unless otherwise indicated in the **BDS**, there is no restriction on the origin of goods other than those prohibited by a decision of the United Nations Security Council taken under Chapter VII of the Charter of the United Nations, subject to **ITB** Clause 27.1.

## **8. Subcontracts**



- 8.1. Unless otherwise specified in the **BDS**, the Bidder may subcontract portions of the Goods to an extent as may be approved by the Procuring Entity and stated in the **BDS**. However, subcontracting of any portion shall not relieve the Bidder from any liability or obligation that may arise from the contract for this Project.
- 8.2. Subcontractors must submit the documentary requirements under **ITB** Clause 12 and comply with the eligibility criteria specified in the **BDS**. In the event that any subcontractor is found by the Procuring Entity to be ineligible, the subcontracting of such portion of the Goods shall be disallowed.
- 8.3. The Bidder may identify the subcontractor to whom a portion of the Goods will be subcontracted at any stage of the bidding process or during contract implementation. If the Bidder opts to disclose the name of the subcontractor during bid submission, the Bidder shall include the required documents as part of the technical component of its bid.

## **B. Contents of Bidding Documents**

### **9. Pre-Bid Conference**

- 9.1. (a) If so specified in the **BDS**, a pre-bid conference shall be held at the venue and on the date indicated therein, to clarify and address the Bidders' questions on the technical and financial components of this Project.  
  
(b) The pre-bid conference shall be held at least twelve (12) calendar days before the deadline for the submission and receipt of bids, but not earlier than seven (7) calendar days from the posting of the invitation to bid/bidding documents in the PhilGEPS website. If the Procuring Entity determines that, by reason of the method, nature, or complexity of the contract to be bid, or when international participation will be more advantageous to the GOP, a longer period for the preparation of bids is necessary, the pre-bid conference shall be held at least thirty (30) calendar days before the deadline for the submission and receipt of bids, as specified in the **BDS**.
- 9.2. Bidders are encouraged to attend the pre-bid conference to ensure that they fully understand the Procuring Entity's requirements. Non-attendance of the Bidder will in no way prejudice its bid; however, the Bidder is expected to know the changes and/or amendments to the Bidding Documents as recorded in the minutes of the pre-bid conference and the Supplemental/Bid Bulletin. The minutes of the pre-bid conference shall be recorded and prepared not later than five (5) calendar days after the pre-bid conference. The minutes shall be made available to prospective bidders not later than five (5) days upon written request.
- 9.3. Decisions of the BAC amending any provision of the bidding documents shall be issued in writing through a Supplemental/Bid Bulletin at least seven (7) calendar days before the deadline for the submission and receipt of bids.

### **10. Clarification and Amendment of Bidding Documents**

- 10.1. Prospective bidders may request for clarification on and/or interpretation of any part of the Bidding Documents. Such request must be in writing and submitted to the Procuring Entity at the address indicated in the **BDS** at least ten (10) calendar days before the deadline set for the submission and receipt of Bids.
- 10.2. The BAC shall respond to the said request by issuing a Supplemental/Bid Bulletin, to be made available to all those who have properly secured the Bidding Documents, at least seven (7) calendar days before the deadline for the submission and receipt of Bids.
- 10.3. Supplemental/Bid Bulletins may also be issued upon the Procuring Entity's initiative for purposes of clarifying or modifying any provision of the Bidding Documents not later than seven (7) calendar days before the deadline for the submission and receipt of Bids. Any modification to the Bidding Documents shall be identified as an amendment.
- 10.4. Any Supplemental/Bid Bulletin issued by the BAC shall also be posted in the PhilGEPS and the website of the Procuring Entity concerned, if available, and at any conspicuous place in the premises of the Procuring Entity concerned. It shall be the responsibility of all Bidders who have properly secured the Bidding Documents to inquire and secure Supplemental/Bid Bulletins that may be issued by the BAC. However, Bidders who have submitted bids before the issuance of the Supplemental/Bid Bulletin must be informed and allowed to modify or withdraw their bids in accordance with **ITB** Clause 23.

## **C. Preparation of Bids**

### **11. Language of Bids**

The eligibility requirements or statements, the bids, and all other documents to be submitted to the BAC must be in English. If the eligibility requirements or statements, the bids, and all other documents submitted to the BAC are in foreign language other than English, it must be accompanied by a translation of the documents in English. The documents shall be translated by the relevant foreign government agency, the foreign government agency authorized to translate documents, or a registered translator in the foreign bidder's country; and shall be authenticated by the appropriate Philippine foreign service establishment/post or the equivalent office having jurisdiction over the foreign bidder's affairs in the Philippines. The English translation shall govern, for purposes of interpretation of the bid.

### **12. Documents Comprising the Bid: Eligibility and Technical Components**

12.1. Unless otherwise indicated in the **BDS**, the first envelope shall contain the following eligibility and technical documents:

- (a) Eligibility Documents –

Class "A" Documents:

- (i) PhilGEPS Certificate of Registration and Membership in accordance with Section 8.5.2 of the IRR, except for foreign bidders participating in the procurement by a Philippine Foreign Service Office or Post, which shall submit their eligibility documents under Section 23.1 of the IRR, provided, that the winning bidder shall register with the PhilGEPS in accordance with section 37.1.4 of the IRR.
- (ii) Statement of all its ongoing government and private contracts, including contracts awarded but not yet started, if any, whether similar or not similar in nature and complexity to the contract to be bid; and

Statement of the Bidder's SLCC similar to the contract to be bid, in accordance with ITB Clause 5.4, within the relevant period as provided in the **BDS**.

The two statements required shall indicate for each contract the following:

- (ii.1) name of the contract;
  - (ii.2) date of the contract;
  - (ii.3) contract duration;
  - (ii.4) owner's name and address;
  - (ii.5) kinds of Goods;
  - (ii.6) For Statement of Ongoing Contracts - amount of contract and value of outstanding contracts;
  - (ii.7) For Statement of SLCC - amount of completed contracts, adjusted by the Bidder to current prices using PSA's consumer price index, if necessary for the purpose of meeting the SLCC requirement;
  - (ii.8) date of delivery; and
  - (ii.9) end user's acceptance or official receipt(s) or sales invoice issued for the contract, if completed, which shall be attached to the statements.
- (iii) NFCC computation in accordance with ITB Clause 5.5 or a committed Line of Credit from a universal or commercial bank.

Class "B" Document:

- (iv) If applicable, the Joint Venture Agreement (JVA) in case the joint venture is already in existence, or duly notarized

statements from all the potential joint venture partners in accordance with Section 23.1(b) of the IRR.

- (b) Technical Documents –
  - (i) Bid security in accordance with **ITB** Clause 18. If the Bidder opts to submit the bid security in the form of:
    - (i.1) a bank draft/guarantee or an irrevocable letter of credit issued by a foreign bank, it shall be accompanied by a confirmation from a Universal or Commercial Bank; or
    - (i.2) a surety bond, it shall be accompanied by a certification by the Insurance Commission that the surety or insurance company is authorized to issue such instruments;
  - (ii) Conformity with technical specifications, as enumerated and specified in Sections VI and VII of the Bidding Documents; and
  - (iii) Sworn statement in accordance with Section 25.3 of the IRR of RA 9184 and using the form prescribed in Section VIII. Bidding Forms.
  - (iv) For foreign bidders claiming eligibility by reason of their country's extension of reciprocal rights to Filipinos, a certification from the relevant government office of their country stating that Filipinos are allowed to participate in their government procurement activities for the same item or product.

### **13. Documents Comprising the Bid: Financial Component**

13.1. The financial component of the bid shall contain the following<sup>1</sup>:

- (a) Financial Bid Form, which includes bid prices and the applicable Price Schedules, in accordance with **ITB** Clauses 15.1 and 15.4;
- (b) If the Bidder claims preference as a Domestic Bidder, a certification from the DTI issued in accordance with **ITB** Clause 27, unless otherwise provided in the **BDS**; and
- (c) Any other document related to the financial component of the bid as stated in the **BDS**.

13.2. (a) Unless otherwise stated in the **BDS**, all bids that exceed the ABC shall not be accepted.

---

<sup>1</sup> GPPB Resolution No. 23–2017, dated 30 May 2017

- (b) Unless otherwise indicated in the **BDS**, for foreign-funded procurement, a ceiling may be applied to bid prices provided the following conditions are met:
  - (i) Bidding Documents are obtainable free of charge on a freely accessible website. If payment of Bidding Documents is required by the procuring entity, payment could be made upon the submission of bids.
  - (ii) The procuring entity has procedures in place to ensure that the ABC is based on recent estimates made by the responsible unit of the procuring entity and that the estimates reflect the quality, supervision and risk and inflationary factors, as well as prevailing market prices, associated with the types of works or goods to be procured.
  - (iii) The procuring entity has trained cost estimators on estimating prices and analyzing bid variances.
  - (iv) The procuring entity has established a system to monitor and report bid prices relative to ABC and engineer's/procuring entity's estimate.
  - (v) The procuring entity has established a monitoring and evaluation system for contract implementation to provide a feedback on actual total costs of goods and works.

## **14. Alternative Bids**

- 14.1 Alternative Bids shall be rejected. For this purpose, alternative bid is an offer made by a Bidder in addition or as a substitute to its original bid which may be included as part of its original bid or submitted separately therewith for purposes of bidding. A bid with options is considered an alternative bid regardless of whether said bid proposal is contained in a single envelope or submitted in two (2) or more separate bid envelopes.
- 14.2 Each Bidder shall submit only one Bid, either individually or as a partner in a JV. A Bidder who submits or participates in more than one bid (other than as a subcontractor if a subcontractor is permitted to participate in more than one bid) will cause all the proposals with the Bidder's participation to be disqualified. This shall be without prejudice to any applicable criminal, civil and administrative penalties that may be imposed upon the persons and entities concerned.

## **15. Bid Prices**

- 15.1. The Bidder shall complete the appropriate Schedule of Prices included herein, stating the unit prices, total price per item, the total amount and the expected countries of origin of the Goods to be supplied under this Project.

- 15.2. The Bidder shall fill in rates and prices for all items of the Goods described in the Schedule of Prices. Bids not addressing or providing all of the required items in the Bidding Documents including, where applicable, Schedule of Prices, shall be considered non-responsive and, thus, automatically disqualified. In this regard, where a required item is provided, but no price is indicated, the same shall be considered as non-responsive, but specifying a zero (0) or a dash (-) for the said item would mean that it is being offered for free to the Government, except those required by law or regulations to be accomplished.
- 15.3. The terms Ex Works (EXW), Cost, Insurance and Freight (CIF), Cost and Insurance Paid to (CIP), Delivered Duty Paid (DDP), and other trade terms used to describe the obligations of the parties, shall be governed by the rules prescribed in the current edition of the International Commercial Terms (INCOTERMS) published by the International Chamber of Commerce, Paris.
- 15.4. Prices indicated on the Price Schedule shall be entered separately in the following manner:
- (a) For Goods offered from within the Procuring Entity's country:
    - (i) The price of the Goods quoted EXW (ex works, ex factory, ex warehouse, ex showroom, or off-the-shelf, as applicable);
    - (ii) The cost of all customs duties and sales and other taxes already paid or payable;
    - (iii) The cost of transportation, insurance, and other costs incidental to delivery of the Goods to their final destination; and
    - (iv) The price of other (incidental) services, if any, listed in the **BDS**.
  - (b) For Goods offered from abroad:
    - (i) Unless otherwise stated in the **BDS**, the price of the Goods shall be quoted DDP with the place of destination in the Philippines as specified in the **BDS**. In quoting the price, the Bidder shall be free to use transportation through carriers registered in any eligible country. Similarly, the Bidder may obtain insurance services from any eligible source country.
    - (ii) The price of other (incidental) services, if any, listed in the **BDS**.
  - (c) For Services, based on the form which may be prescribed by the Procuring Entity, in accordance with existing laws, rules and regulations
- 15.5. Prices quoted by the Bidder shall be fixed during the Bidder's performance of the contract and not subject to variation or price escalation on any account. A

bid submitted with an adjustable price quotation shall be treated as non-responsive and shall be rejected, pursuant to **ITB** Clause 24.

All bid prices for the given scope of work in the contract as awarded shall be considered as fixed prices, and therefore not subject to price escalation during contract implementation, except under extraordinary circumstances. Upon the recommendation of the Procuring Entity, price escalation may be allowed in extraordinary circumstances as may be determined by the National Economic and Development Authority in accordance with the Civil Code of the Philippines, and upon approval by the GPPB. Nevertheless, in cases where the cost of the awarded contract is affected by any applicable new laws, ordinances, regulations, or other acts of the GOP, promulgated after the date of bid opening, a contract price adjustment shall be made or appropriate relief shall be applied on a no loss-no gain basis.

## 16. Bid Currencies

16.1. Prices shall be quoted in the following currencies:

- (a) For Goods that the Bidder will supply from within the Philippines, the prices shall be quoted in Philippine Pesos.
- (b) For Goods that the Bidder will supply from outside the Philippines, the prices may be quoted in the currency(ies) stated in the **BDS**. However, for purposes of bid evaluation, bids denominated in foreign currencies shall be converted to Philippine currency based on the exchange rate as published in the *Bangko Sentral ng Pilipinas* (BSP) reference rate bulletin on the day of the bid opening.

16.2. If so allowed in accordance with **ITB** Clause 16.1, the Procuring Entity for purposes of bid evaluation and comparing the bid prices will convert the amounts in various currencies in which the bid price is expressed to Philippine Pesos at the foregoing exchange rates.

16.3. Unless otherwise specified in the **BDS**, payment of the contract price shall be made in Philippine Pesos.

## 17. Bid Validity

17.1. Bids shall remain valid for the period specified in the **BDS** which shall not exceed one hundred twenty (120) calendar days from the date of the opening of bids.

17.2. In exceptional circumstances, prior to the expiration of the bid validity period, the Procuring Entity may request Bidders to extend the period of validity of their bids. The request and the responses shall be made in writing. The bid security described in **ITB** Clause 18 should also be extended corresponding to the extension of the bid validity period at the least. A Bidder may refuse the request without forfeiting its bid security, but his bid shall no longer be considered for further evaluation and award. A Bidder granting the request shall not be required or permitted to modify its bid.

## 18. Bid Security

- 18.1. The Bidder shall submit a Bid Securing Declaration or any form of Bid Security in the amount stated in the **BDS**, which shall be not less than the percentage of the ABC in accordance with the following schedule:

Form of Bid Security	Amount of Bid Security (Not Less than the Percentage of the ABC)
(a) Cash or cashier's/manager's check issued by a Universal or Commercial Bank.	Two percent (2%)
(b) Bank draft/guarantee or irrevocable letter of credit issued by a Universal or Commercial Bank: Provided, however, that it shall be confirmed or authenticated by a Universal or Commercial Bank, if issued by a foreign bank.	
(c) Surety bond callable upon demand issued by a surety or insurance company duly certified by the Insurance Commission as authorized to issue such security.	Five percent (5%)

The Bid Securing Declaration mentioned above is an undertaking which states, among others, that the Bidder shall enter into contract with the procuring entity and furnish the performance security required under ITB Clause 33.2, within ten (10) calendar days from receipt of the Notice of Award, and commits to pay the corresponding amount as fine, and be suspended for a period of time from being qualified to participate in any government procurement activity in the event it violates any of the conditions stated therein as provided in the guidelines issued by the GPPB.

- 18.2. The bid security should be valid for the period specified in the **BDS**. Any bid not accompanied by an acceptable bid security shall be rejected by the Procuring Entity as non-responsive.
- 18.3. No bid securities shall be returned to Bidders after the opening of bids and before contract signing, except to those that failed or declared as post-disqualified, upon submission of a written waiver of their right to file a request for reconsideration and/or protest, or upon the lapse of the reglementary period to file a request for reconsideration or protest. Without prejudice on its forfeiture, bid securities shall be returned only after the Bidder with the Lowest Calculated Responsive Bid (LCRB) has signed the contract and furnished the performance security, but in no case later than the expiration of the bid security validity period indicated in **ITB** Clause 18.2.



18.4. Upon signing and execution of the contract pursuant to **ITB** Clause 32, and the posting of the performance security pursuant to **ITB** Clause 33, the successful Bidder's bid security will be discharged, but in no case later than the bid security validity period as indicated in the **ITB** Clause 18.2.

18.5. The bid security may be forfeited:

(a) if a Bidder:

- (i) withdraws its bid during the period of bid validity specified in **ITB** Clause 17;
- (ii) does not accept the correction of errors pursuant to **ITB** Clause 28.3(b);
- (iii) has a finding against the veracity of any of the documents submitted as stated in **ITB** Clause 29.2;
- (iv) submission of eligibility requirements containing false information or falsified documents;
- (v) submission of bids that contain false information or falsified documents, or the concealment of such information in the bids in order to influence the outcome of eligibility screening or any other stage of the public bidding;
- (vi) allowing the use of one's name, or using the name of another for purposes of public bidding;
- (vii) withdrawal of a bid, or refusal to accept an award, or enter into contract with the Government without justifiable cause, after the Bidder had been adjudged as having submitted the LCRB;
- (viii) refusal or failure to post the required performance security within the prescribed time;
- (ix) refusal to clarify or validate in writing its bid during post-qualification within a period of seven (7) calendar days from receipt of the request for clarification;
- (x) any documented attempt by a Bidder to unduly influence the outcome of the bidding in his favor;
- (xi) failure of the potential joint venture partners to enter into the joint venture after the bid is declared successful; or
- (xii) all other acts that tend to defeat the purpose of the competitive bidding, such as habitually withdrawing from bidding, submitting late Bids or patently insufficient bid, for at least three (3) times within a year, except for valid reasons.

(b) if the successful Bidder:

- (i) fails to sign the contract in accordance with **ITB** Clause 32; or
- (ii) fails to furnish performance security in accordance with **ITB** Clause 33.

## **19. Format and Signing of Bids**

- 19.1. Bidders shall submit their bids through their duly authorized representative using the appropriate forms provided in Section VIII. Bidding Forms on or before the deadline specified in the **ITB** Clauses 21 in two (2) separate sealed bid envelopes, and which shall be submitted simultaneously. The first shall contain the technical component of the bid, including the eligibility requirements under **ITB** Clause 12.1, and the second shall contain the financial component of the bid. This shall also be observed for each lot in the case of lot procurement.
- 19.2. Forms as mentioned in **ITB** Clause 19.1 must be completed without any alterations to their format, and no substitute form shall be accepted. All blank spaces shall be filled in with the information requested.
- 19.3. The Bidder shall prepare and submit an original of the first and second envelopes as described in **ITB** Clauses 12 and 13. In addition, the Bidder shall submit copies of the first and second envelopes. In the event of any discrepancy between the original and the copies, the original shall prevail.
- 19.4. Each and every page of the Bid Form, including the Schedule of Prices, under Section VIII hereof, shall be signed by the duly authorized representative/s of the Bidder. Failure to do so shall be a ground for the rejection of the bid.
- 19.5. Any interlineations, erasures, or overwriting shall be valid only if they are signed or initialed by the duly authorized representative/s of the Bidder.

## **20. Sealing and Marking of Bids**

- 20.1. Bidders shall enclose their original eligibility and technical documents described in **ITB** Clause 12 in one sealed envelope marked “ORIGINAL - TECHNICAL COMPONENT”, and the original of their financial component in another sealed envelope marked “ORIGINAL - FINANCIAL COMPONENT”, sealing them all in an outer envelope marked “ORIGINAL BID”.
- 20.2. Each copy of the first and second envelopes shall be similarly sealed duly marking the inner envelopes as “COPY NO. \_\_\_ - TECHNICAL COMPONENT” and “COPY NO. \_\_\_ – FINANCIAL COMPONENT” and the outer envelope as “COPY NO. \_\_\_”, respectively. These envelopes containing the original and the copies shall then be enclosed in one single envelope.
- 20.3. The original and the number of copies of the Bid as indicated in the **BDS** shall be typed or written in ink and shall be signed by the Bidder or its duly authorized representative/s.

- 20.4. All envelopes shall:
- (a) contain the name of the contract to be bid in capital letters;
  - (b) bear the name and address of the Bidder in capital letters;
  - (c) be addressed to the Procuring Entity's BAC in accordance with **ITB** Clause 1.1;
  - (d) bear the specific identification of this bidding process indicated in the **ITB** Clause 1.2; and
  - (e) bear a warning "DO NOT OPEN BEFORE..." the date and time for the opening of bids, in accordance with **ITB** Clause 21.
- 20.5. Bid envelopes that are not properly sealed and marked, as required in the bidding documents, shall not be rejected, but the Bidder or its duly authorized representative shall acknowledge such condition of the bid as submitted. The BAC or the Procuring Entity shall assume no responsibility for the misplacement of the contents of the improperly sealed or marked bid, or for its premature opening.

## **D. Submission and Opening of Bids**

### **21. Deadline for Submission of Bids**

Bids must be received by the Procuring Entity's BAC at the address and on or before the date and time indicated in the **BDS**.

### **22. Late Bids**

Any bid submitted after the deadline for submission and receipt of bids prescribed by the Procuring Entity, pursuant to **ITB** Clause 21, shall be declared "Late" and shall not be accepted by the Procuring Entity. The BAC shall record in the minutes of bid submission and opening, the Bidder's name, its representative and the time the late bid was submitted.

### **23. Modification and Withdrawal of Bids**

23.1. The Bidder may modify its bid after it has been submitted; provided that the modification is received by the Procuring Entity prior to the deadline prescribed for submission and receipt of bids. The Bidder shall not be allowed to retrieve its original bid, but shall be allowed to submit another bid equally sealed and properly identified in accordance with **ITB** Clause 20, linked to its original bid marked as "TECHNICAL MODIFICATION" or "FINANCIAL MODIFICATION" and stamped "received" by the BAC. Bid modifications received after the applicable deadline shall not be considered and shall be returned to the Bidder unopened.

23.2 A Bidder may, through a Letter of Withdrawal, withdraw its bid after it has been submitted, for valid and justifiable reason; provided that the Letter of

Withdrawal is received by the Procuring Entity prior to the deadline prescribed for submission and receipt of bids. The Letter of Withdrawal must be executed by the duly authorized representative of the Bidder identified in the Omnibus Sworn Statement, a copy of which should be attached to the letter.

- 23.3. Bids requested to be withdrawn in accordance with **ITB** Clause 23.1 shall be returned unopened to the Bidders. A Bidder, who has acquired the bidding documents, may also express its intention not to participate in the bidding through a letter which should reach and be stamped by the BAC before the deadline for submission and receipt of bids. A Bidder that withdraws its bid shall not be permitted to submit another bid, directly or indirectly, for the same contract.
- 23.4. No bid may be modified after the deadline for submission of bids. No bid may be withdrawn in the interval between the deadline for submission of bids and the expiration of the period of bid validity specified by the Bidder on the Financial Bid Form. Withdrawal of a bid during this interval shall result in the forfeiture of the Bidder's bid security, pursuant to **ITB** Clause 18.5, and the imposition of administrative, civil and criminal sanctions as prescribed by RA 9184 and its IRR.

## **24. Opening and Preliminary Examination of Bids**

- 24.1. The BAC shall open the bids in public, immediately after the deadline for the submission and receipt of bids, as specified in the **BDS**. In case the Bids cannot be opened as scheduled due to justifiable reasons, the BAC shall take custody of the Bids submitted and reschedule the opening of Bids on the next working day or at the soonest possible time through the issuance of a Notice of Postponement to be posted in the PhilGEPS website and the website of the Procuring Entity concerned.
- 24.2. Unless otherwise specified in the **BDS**, the BAC shall open the first bid envelopes and determine each Bidder's compliance with the documents prescribed in **ITB** Clause 12, using a non-discretionary "pass/fail" criterion. If a Bidder submits the required document, it shall be rated "passed" for that particular requirement. In this regard, bids that fail to include any requirement or are incomplete or patently insufficient shall be considered as "failed". Otherwise, the BAC shall rate the said first bid envelope as "passed".
- 24.3. Unless otherwise specified in the **BDS**, immediately after determining compliance with the requirements in the first envelope, the BAC shall forthwith open the second bid envelope of each remaining eligible bidder whose first bid envelope was rated "passed". The second envelope of each complying bidder shall be opened within the same day. In case one or more of the requirements in the second envelope of a particular bid is missing, incomplete or patently insufficient, and/or if the submitted total bid price exceeds the ABC unless otherwise provided in **ITB** Clause 13.2, the BAC shall rate the bid concerned as "failed". Only bids that are determined to contain all the bid requirements for both components shall be rated "passed" and shall immediately be considered for evaluation and comparison.

- 24.4. Letters of Withdrawal shall be read out and recorded during bid opening, and the envelope containing the corresponding withdrawn bid shall be returned to the Bidder unopened.
- 24.5. All members of the BAC who are present during bid opening shall initial every page of the original copies of all bids received and opened.
- 24.6. In the case of an eligible foreign bidder as described in **ITB** Clause 5, the following Class “A” Documents may be substituted with the appropriate equivalent documents, if any, issued by the country of the foreign Bidder concerned, which shall likewise be uploaded and maintained in the PhilGEPS in accordance with Section 8.5.2 of the IRR:
- (a) Registration certificate from the Securities and Exchange Commission (SEC), Department of Trade and Industry (DTI) for sole proprietorship, or CDA for cooperatives;
  - (b) Mayor’s/Business permit issued by the local government where the principal place of business of the bidder is located; and
  - (c) Audited Financial Statements showing, among others, the prospective bidder’s total and current assets and liabilities stamped “received” by the Bureau of Internal Revenue or its duly accredited and authorized institutions, for the preceding calendar year which should not be earlier than two years from the date of bid submission.
- 24.7. Each partner of a joint venture agreement shall likewise submit the requirements in **ITB** Clause 12.1(a)(i). Submission of documents required under **ITB** Clauses 12.1(a)(ii) to 12.1(a)(iii) by any of the joint venture partners constitutes compliance.
- 24.8. The Procuring Entity shall prepare the minutes of the proceedings of the bid opening that shall include, as a minimum: (a) names of Bidders, their bid price (per lot, if applicable, and/or including discount, if any), bid security, findings of preliminary examination, and whether there is a withdrawal or modification; and (b) attendance sheet. The BAC members shall sign the abstract of bids as read.
- 24.8. The bidders or their duly authorized representatives may attend the opening of bids. The BAC shall ensure the integrity, security, and confidentiality of all submitted bids. The Abstract of Bids as read and the minutes of the bid opening shall be made available to the public upon written request and payment of a specified fee to recover cost of materials.
- 24.9. To ensure transparency and accurate representation of the bid submission, the BAC Secretariat shall notify in writing all bidders whose bids it has received through its PhilGEPS-registered physical address or official e-mail address. The notice shall be issued within seven (7) calendar days from the date of the bid opening.

## **E. Evaluation and Comparison of Bids**

### **25. Process to be Confidential**

- 25.1. Members of the BAC, including its staff and personnel, as well as its Secretariat and TWG, are prohibited from making or accepting any kind of communication with any bidder regarding the evaluation of their bids until the issuance of the Notice of Award, unless otherwise allowed in the case of **ITB** Clause 26.
- 25.2. Any effort by a bidder to influence the Procuring Entity in the Procuring Entity's decision in respect of bid evaluation, bid comparison or contract award will result in the rejection of the Bidder's bid.

### **26. Clarification of Bids**

To assist in the evaluation, comparison, and post-qualification of the bids, the Procuring Entity may ask in writing any Bidder for a clarification of its bid. All responses to requests for clarification shall be in writing. Any clarification submitted by a Bidder in respect to its bid and that is not in response to a request by the Procuring Entity shall not be considered.

### **27. Domestic Preference**

- 27.1. Unless otherwise stated in the **BDS**, the Procuring Entity will grant a margin of preference for the purpose of comparison of bids in accordance with the following:
- (a) The preference shall be applied when the lowest Foreign Bid is lower than the lowest bid offered by a Domestic Bidder.
  - (b) For evaluation purposes, the lowest Foreign Bid shall be increased by fifteen percent (15%).
  - (c) In the event that the lowest bid offered by a Domestic Bidder does not exceed the lowest Foreign Bid as increased, then the Procuring Entity shall award the contract to the Domestic Bidder at the amount of the lowest Foreign Bid.
  - (d) If the Domestic Bidder refuses to accept the award of contract at the amount of the Foreign Bid within two (2) calendar days from receipt of written advice from the BAC, the Procuring Entity shall award to the bidder offering the Foreign Bid, subject to post-qualification and submission of all the documentary requirements under these Bidding Documents.
- 27.2. A Bidder may be granted preference as a Domestic Bidder subject to the certification from the DTI that the Bidder is offering unmanufactured articles, materials or supplies of the growth or production of the Philippines, or manufactured articles, materials, or supplies manufactured or to be manufactured in the Philippines substantially from articles, materials, or

supplies of the growth, production, or manufacture, as the case may be, of the Philippines.

## **28. Detailed Evaluation and Comparison of Bids**

- 28.1. The Procuring Entity will undertake the detailed evaluation and comparison of bids which have passed the opening and preliminary examination of bids, pursuant to **ITB** Clause 24, in order to determine the Lowest Calculated Bid.
- 28.2. The Lowest Calculated Bid shall be determined in two steps:
  - (a) The detailed evaluation of the financial component of the bids, to establish the correct calculated prices of the bids; and
  - (b) The ranking of the total bid prices as so calculated from the lowest to the highest. The bid with the lowest price shall be identified as the Lowest Calculated Bid.
- 28.3. The Procuring Entity's BAC shall immediately conduct a detailed evaluation of all bids rated "passed," using non-discretionary pass/fail criteria. The BAC shall consider the following in the evaluation of bids:
  - (a) Completeness of the bid. Unless the **BDS** allows partial bids, bids not addressing or providing all of the required items in the Schedule of Requirements including, where applicable, Schedule of Prices, shall be considered non-responsive and, thus, automatically disqualified. In this regard, where a required item is provided, but no price is indicated, the same shall be considered as non-responsive, but specifying a zero (0) or a dash (-) for the said item would mean that it is being offered for free to the Procuring Entity, except those required by law or regulations to be provided for; and
  - (b) Arithmetical corrections. Consider computational errors and omissions to enable proper comparison of all eligible bids. It may also consider bid modifications. Any adjustment shall be calculated in monetary terms to determine the calculated prices.
- 28.4. Based on the detailed evaluation of bids, those that comply with the above-mentioned requirements shall be ranked in the ascending order of their total calculated bid prices, as evaluated and corrected for computational errors, discounts and other modifications, to identify the Lowest Calculated Bid. Total calculated bid prices, as evaluated and corrected for computational errors, discounts and other modifications, which exceed the ABC shall not be considered, unless otherwise indicated in the **BDS**.
- 28.5. The Procuring Entity's evaluation of bids shall be based on the bid price quoted in the Bid Form, which includes the Schedule of Prices.
- 28.6. Bids shall be evaluated on an equal footing to ensure fair competition. For this purpose, all bidders shall be required to include in their bids the cost of all taxes, such as, but not limited to, value added tax (VAT), income tax, local

taxes, and other fiscal levies and duties which shall be itemized in the bid form and reflected in the detailed estimates. Such bids, including said taxes, shall be the basis for bid evaluation and comparison.

- 28.7. If so indicated pursuant to **ITB** Clause 1.2, Bids are being invited for individual lots or for any combination thereof, provided that all Bids and combinations of Bids shall be received by the same deadline and opened and evaluated simultaneously so as to determine the Bid or combination of Bids offering the lowest calculated cost to the Procuring Entity. Bid prices quoted shall correspond to all items specified for each lot and to all quantities specified for each item of a lot. Bid Security as required by **ITB** Clause 18 shall be submitted for each contract (lot) separately. The basis for evaluation of lots is specified in BDS Clause 28.3.

## **29. Post-Qualification**

- 29.1. The BAC shall determine to its satisfaction whether the Bidder that is evaluated as having submitted the Lowest Calculated Bid complies with and is responsive to all the requirements and conditions specified in **ITB** Clauses 5, 12, and 13.

- 29.2. Within a non-extendible period of five (5) calendar days from receipt by the bidder of the notice from the BAC that it submitted the Lowest Calculated Bid, the Bidder shall submit its latest income and business tax returns filed and paid through the BIR Electronic Filing and Payment System (eFPS) and other appropriate licenses and permits required by law and stated in the **BDS**.

Failure to submit any of the post-qualification requirements on time, or a finding against the veracity thereof, shall disqualify the bidder for award. Provided in the event that a finding against the veracity of any of the documents submitted is made, it shall cause the forfeiture of the bid security in accordance with Section 69 of the IRR of RA 9184.

- 29.3. The determination shall be based upon an examination of the documentary evidence of the Bidder's qualifications submitted pursuant to **ITB** Clauses 12 and 13, as well as other information as the Procuring Entity deems necessary and appropriate, using a non-discretionary "pass/fail" criterion, which shall be completed within a period of twelve (12) calendar days.
- 29.4. If the BAC determines that the Bidder with the Lowest Calculated Bid passes all the criteria for post-qualification, it shall declare the said bid as the LCRB, and recommend to the HoPE the award of contract to the said Bidder at its submitted price or its calculated bid price, whichever is lower.
- 29.5. A negative determination shall result in rejection of the Bidder's Bid, in which event the Procuring Entity shall proceed to the next Lowest Calculated Bid with a fresh period to make a similar determination of that Bidder's capabilities to perform satisfactorily. If the second Bidder, however, fails the post qualification, the procedure for post qualification shall be repeated for the Bidder with the next Lowest Calculated Bid, and so on until the LCRB is determined for recommendation for contract award.



- 29.6. Within a period not exceeding fifteen (15) calendar days from the determination by the BAC of the LCRB and the recommendation to award the contract, the HoPE or his duly authorized representative shall approve or disapprove the said recommendation.
- 29.7. In the event of disapproval, which shall be based on valid, reasonable, and justifiable grounds as provided for under Section 41 of the IRR of RA 9184, the HoPE shall notify the BAC and the Bidder in writing of such decision and the grounds for it. When applicable, the BAC shall conduct a post-qualification of the Bidder with the next Lowest Calculated Bid. A request for reconsideration may be filed by the bidder with the HoPE in accordance with Section 37.1.3 of the IRR of RA 9184.

### **30. Reservation Clause**

- 30.1. Notwithstanding the eligibility or post-qualification of a Bidder, the Procuring Entity concerned reserves the right to review its qualifications at any stage of the procurement process if it has reasonable grounds to believe that a misrepresentation has been made by the said Bidder, or that there has been a change in the Bidder's capability to undertake the project from the time it submitted its eligibility requirements. Should such review uncover any misrepresentation made in the eligibility and bidding requirements, statements or documents, or any changes in the situation of the Bidder which will affect its capability to undertake the project so that it fails the preset eligibility or bid evaluation criteria, the Procuring Entity shall consider the said Bidder as ineligible and shall disqualify it from submitting a bid or from obtaining an award or contract.
- 30.2. Based on the following grounds, the Procuring Entity reserves the right to reject any and all bids, declare a Failure of Bidding at any time prior to the contract award, or not to award the contract, without thereby incurring any liability, and make no assurance that a contract shall be entered into as a result of the bidding:
  - (a) If there is *prima facie* evidence of collusion between appropriate public officers or employees of the Procuring Entity, or between the BAC and any of the Bidders, or if the collusion is between or among the bidders themselves, or between a Bidder and a third party, including any act which restricts, suppresses or nullifies or tends to restrict, suppress or nullify competition;
  - (b) If the Procuring Entity's BAC is found to have failed in following the prescribed bidding procedures; or
  - (c) For any justifiable and reasonable ground where the award of the contract will not redound to the benefit of the GOP as follows:
    - (i) If the physical and economic conditions have significantly changed so as to render the project no longer economically, financially or technically feasible as determined by the HoPE;

- (ii) If the project is no longer necessary as determined by the HoPE; and
  - (iii) If the source of funds for the project has been withheld or reduced through no fault of the Procuring Entity.
- 30.3. In addition, the Procuring Entity may likewise declare a failure of bidding when:
  - (a) No bids are received;
  - (b) All prospective Bidders are declared ineligible;
  - (c) All bids fail to comply with all the bid requirements or fail post-qualification; or
  - (d) The bidder with the LCRB refuses, without justifiable cause to accept the award of contract, and no award is made in accordance with Section 40 of the IRR of RA 9184.

## **Award of Contract**

### **31. Contract Award**

- 31.1. Subject to **ITB** Clause 29, the HoPE or its duly authorized representative shall award the contract to the Bidder whose bid has been determined to be the LCRB.
- 31.2. Prior to the expiration of the period of bid validity, the Procuring Entity shall notify the successful Bidder in writing that its bid has been accepted, through a Notice of Award duly received by the Bidder or its representative personally or sent by registered mail or electronically, receipt of which must be confirmed in writing within two (2) days by the Bidder with the LCRB and submitted personally or sent by registered mail or electronically to the Procuring Entity.
- 31.3. Notwithstanding the issuance of the Notice of Award, award of contract shall be subject to the following conditions:
  - (a) Submission of the following documents within ten (10) calendar days from receipt of the Notice of Award:
    - (i) Valid JVA, if applicable; or
    - (ii) In the case of procurement by a Philippine Foreign Service Office or Post, the PhilGEPS Registration Number of the winning foreign Bidder;
  - (b) Posting of the performance security in accordance with **ITB** Clause 33;
  - (c) Signing of the contract as provided in **ITB** Clause 32; and

- (d) Approval by higher authority, if required, as provided in Section 37.3 of the IRR of RA 9184.

31.4. At the time of contract award, the Procuring Entity shall not increase or decrease the quantity of goods originally specified in Section VI. Schedule of Requirements.

## **32. Signing of the Contract**

32.1. At the same time as the Procuring Entity notifies the successful Bidder that its bid has been accepted, the Procuring Entity shall send the Contract Form to the Bidder, which contract has been provided in the Bidding Documents, incorporating therein all agreements between the parties.

32.2. Within ten (10) calendar days from receipt of the Notice of Award, the successful Bidder shall post the required performance security, sign and date the contract and return it to the Procuring Entity.

32.3. The Procuring Entity shall enter into contract with the successful Bidder within the same ten (10) calendar day period provided that all the documentary requirements are complied with.

32.4. The following documents shall form part of the contract:

- (a) Contract Agreement;
- (b) Bidding Documents;
- (c) Winning bidder's bid, including the Technical and Financial Proposals, and all other documents/statements submitted (*e.g.*, bidder's response to request for clarifications on the bid), including corrections to the bid, if any, resulting from the Procuring Entity's bid evaluation;
- (d) Performance Security;
- (e) Notice of Award of Contract; and
- (f) Other contract documents that may be required by existing laws and/or specified in the **BDS**.

## **33. Performance Security**

33.1. To guarantee the faithful performance by the winning Bidder of its obligations under the contract, it shall post a performance security within a maximum period of ten (10) calendar days from the receipt of the Notice of Award from the Procuring Entity and in no case later than the signing of the contract.

33.2. The Performance Security shall be denominated in Philippine Pesos and posted in favor of the Procuring Entity in an amount not less than the percentage of the total contract price in accordance with the following schedule:

Form of Performance Security	Amount of Performance Security (Not less than the Percentage of the Total Contract Price)
(a) Cash or cashier's/manager's check issued by a Universal or Commercial Bank.	
(b) Bank draft/guarantee or irrevocable letter of credit issued by a Universal or Commercial Bank: Provided, however, that it shall be confirmed or authenticated by a Universal or Commercial Bank, if issued by a foreign bank.	Five percent (5%)
(c) Surety bond callable upon demand issued by a surety or insurance company duly certified by the Insurance Commission as authorized to issue such security.	Thirty percent (30%)

33.3. Failure of the successful Bidder to comply with the above-mentioned requirement shall constitute sufficient ground for the annulment of the award and forfeiture of the bid security, in which event the Procuring Entity shall have a fresh period to initiate and complete the post qualification of the second Lowest Calculated Bid. The procedure shall be repeated until the LCRB is identified and selected for recommendation of contract award. However if no Bidder passed post-qualification, the BAC shall declare the bidding a failure and conduct a re-bidding with re-advertisement, if necessary.

### **34. Notice to Proceed**

Within seven (7) calendar days from the date of approval of the contract by the appropriate government approving authority, the Procuring Entity shall issue the Notice to Proceed (NTP) together with a copy or copies of the approved contract to the successful Bidder. All notices called for by the terms of the contract shall be effective only at the time of receipt thereof by the successful Bidder.

### **35. Protest Mechanism**

Decisions of the procuring entity at any stage of the procurement process may be questioned in accordance with Section 55 of the IRR of RA 9184.

## ***Section III. Bid Data Sheet***

# Bid Data Sheet

ITB Clause	
1.1	<p>The Procuring Entity is <b>Department of Social Welfare and Development (DSWD) –Information and Communications Technology Management Service (ICTMS)</b>.</p> <p>The name of the Contract is <b>Subscription of Local Area Network Services for DSWD Central Office New Building</b>.</p> <p>The identification number of the Contract is <b>ITB No. GOP/19-DSWD-007</b>.</p>
1.2	<p>The lot and reference are:</p> <p><b>Subscription of Local Area Network Services for DSWD Central Office New Building</b></p> <p><b>ITB No. GOP/19-DSWD-007</b></p>
2	<p>The Funding Source is:</p> <p>The Government of the Philippines (GOP) through <b>Information and Communications Technology Management Service (ICTMS) – Miscellaneous and Other Operating Expenses (MOOE) Funds</b>, in the amount of <b>Thirteen Million Three Hundred Thirty-Two Thousand Pesos (PhP 13,332,000.00)</b></p> <p>The name of the Project is:</p> <p><b>Subscription of Local Area Network Services for DSWD Central Office New Building</b></p>
3.1	No further instructions.
5.1	No further instructions.
5.2	Foreign bidders, except those falling under ITB Clause 5.2(b), may not participate in this Project.
5.4	<p>The Bidder must have completed, within the period specified in the Invitation to Bid and <b>ITB Clause 12.1(a)(ii)</b>, a single contract that is similar to this Project, equivalent to at least fifty percent (50%) of the ABC.</p> <p>For this purpose, similar contracts shall refer to the <b>subscription to local area network services or supply or delivery or installation of network services and/or structure cabling systems</b>.</p>
7	No further instructions.
8.1	<b>Subcontracting is not allowed.</b>

8.2	Not applicable.
9.1	The DSWD will hold a pre-bid conference for this Project on <b>19 December 2018, 02:00 p.m.</b> at <b>Social Technology Bureau Conference Room, 3<sup>rd</sup> Floor, DSWD Central Office, IBP Road, Constitution Hills, Quezon City</b> which shall be open to prospective bidders.
10.1	The Procuring Entity's address is:  <b>THE CHAIRPERSON</b> Bids and Awards Committee c/o BAC Secretariat Ground Floor, DSWD Central Office IBP Road, Constitution Hills, Quezon City Fax No. (02) 931-6139 Telephone nos. (02) 931-8101 to 07 Local 122 or 124 Email Address: <b>bacsec@dswd.gov.ph</b>
12.1(a)	Prospective bidders may still submit their Class "A" Eligibility Documents, to wit:  a. Registration Certificate from Security and Exchange Commission (SEC) for Corporations, Department of Trade and Industry (DTI) for Sole Proprietorships or Cooperative Development Authority (CDA) for Cooperatives; b. Valid Mayor's/ Business Permit or its Equivalent Document; c. Valid Tax Clearance; and d. Audited Financial Statements stamped "received" by the Bureau of Internal Revenue (BIR) or its duly accredited and authorized institutions, for the preceding calendar year, which should not be earlier than two (2) years from bid submission.  Or  If the prospective bidder is already registered in the PhilGEPS under Platinum category, their Certificate Registration and Membership in lieu of their uploaded file of Class "A" Documents must be submitted, or a combination thereof.  In case the bidder opted to submit their Class "A" Documents, the Certificate of PhilGEPS Registration (Platinum Membership) shall remain as post-qualification requirements to be submitted in accordance with Section 34.2 of the 2016 Revised IRR of RA 9184.
12.1(a)(ii)	The bidder's SLCC similar to the contract to be bid should have been completed within <b>five (5) years</b> prior to the deadline for the submission and receipt of bids.
13.1(b)	No further instructions.

13.1(c)	No additional requirements.
13.2	The total ABC is <b>Thirteen Million Three Hundred Thirty-Two Thousand Pesos (PhP 13,332,000.00)</b> .  Any bid with a financial component exceeding this amount shall not be accepted.
15.4(a)(iv)	No incidental services are required.
15.4(b)(i) <sup>2</sup>	Not applicable.
15.4(b)(ii) <sup>3</sup>	No incidental services are required.
16.1(b)	The Bid prices for Goods supplied from outside of the Philippines shall be quoted in Philippine Pesos.
16.3	Not applicable.
17.1	Bids will be valid until <b><i>One Hundred Twenty (120) calendar days</i></b> from the date of opening of bids.
18.1	The bid security shall be in the form of a Bid Securing Declaration, or any of the following forms and amounts:  1. The amount of not less than <b>PhP 266,640.00</b> , if bid security is in cash, cashier's/manager's check, bank draft/guarantee or irrevocable letter of credit; or  2. The amount of not less than <b>PhP 666,600.00</b> , if bid security is in Surety Bond.
18.2	The bid security shall be valid until <b><i>One Hundred Twenty (120) calendar days</i></b> from the date of opening of bids.
20.3	Each Bidder shall submit <b>one (1) original</b> and <b>one (1) copy</b> of the first and second components of its bid.
21	The address for submission of bids is <b>BAC Secretariat, Ground Floor, DSWD Central office, IBP Road, Constitution Hills, Quezon City</b> .  The deadline for submission of bids is <b><i>04 January 2019, 09:00 a.m.</i></b>
24.1	The place of bid opening is at <b>Legal Service Conference Room, 4<sup>th</sup> Floor, DSWD Central Office, IBP Road, Constitution Hills, Quezon City</b> .  The date and time of bid opening is <b><i>04 January 2018, 11:00 a.m.</i></b>

<sup>2</sup> GPPB Resolution No. 23-2017, dated 30 May 2017

<sup>3</sup> GPPB Resolution No. 23-2017, dated 30 May 2017



24.2	No further instructions.
24.3	No further instructions.
27.1	No further instructions.
28.3 (a)	<p><b>Grouping and Evaluation of Lots –</b></p> <p>Partial bid is not allowed. The goods are grouped in a single lot and the lot shall not be divided into sub-lots for the purpose of bidding, evaluation, and contract award.</p>
28.4	No further instructions.
29.2	<p>The Lowest Calculated Bid (LCB) or Single Calculated Bid (SCB) as the case may be, shall submit the following additional documents during the Post-Qualification Stage:</p> <ol style="list-style-type: none"> <li>1) Latest income tax returns (ITR) are those covering the immediately preceding year while latest business tax returns (BTR) are those filed within the last six (6) months preceding the date of bid submission;</li> <li>2) Certificate of PhilGEPS Registration (Platinum Membership), if not submitted during bid opening;</li> <li>3) Certification from the Service Provider stating that it has done at least five (5) successful projects involving the quoted service with certifications and proof of satisfactory performance issued by its previous or existing clients; <b>(Original and duly notarized)</b></li> <li>4) Certification that the offered brand is an international brand, and have been continuously marketed in the Philippines for the last ten (10) years; <b>(Original and duly notarized)</b></li> <li>5) Certification that the Service Provider have been in the business of providing networking services and structure cabling system for the last ten (10) years; <b>(Original and duly notarized)</b></li> <li>6) Certification that the Service Provider have certified Engineers of the offered brand for both network equipment and cabling. Submit list of certified Engineers for the offered brand; <b>(Certified True Copy)</b></li> <li>7) Certification that the Service Provider have a Project Manager who is a Project Management Professional (PMP) certified and have five (5) years of project management managing nationwide deployment. Submit curriculum vitae and appropriate certificates of trainings and seminars of the Project Manager; and, <b>(Certified True Copy)</b></li> <li>8) Certificates from ANSI, TIA, EIA and ISO/IEC 11801 that the Service Provider is a certified installer of structured cabling system. <b>(Certified True Copy)</b></li> </ol>

32.4(f)	<p>The Lowest Calculated and Responsive Bidder (LCRB) or Single Calculated and Responsive Bidder (SRCB) who opted to submit Surety Bond as form of Performance Security shall submit a certification from the Insurance Commission indicating the following details:</p> <ol style="list-style-type: none"><li data-bbox="411 376 1402 450">1. The Certification was issued in favor of an insurance/boding company; and</li><li data-bbox="411 483 1402 557">2. The insurance/bonding company is authorized to issue bonds/ sureties in favor of the service provider for the said project.</li></ol>
---------	--

## ***Section IV. General Conditions of Contract***

## **TABLE OF CONTENTS**

<b>1. DEFINITIONS .....</b>	<b>45</b>
<b>2. CORRUPT, FRAUDULENT, COLLUSIVE, AND COERCIVE PRACTICES.....</b>	<b>46</b>
<b>3. INSPECTION AND AUDIT BY THE FUNDING SOURCE .....</b>	<b>47</b>
<b>4. GOVERNING LAW AND LANGUAGE.....</b>	<b>47</b>
<b>5. NOTICES.....</b>	<b>47</b>
<b>6. SCOPE OF CONTRACT.....</b>	<b>48</b>
<b>7. SUBCONTRACTING.....</b>	<b>48</b>
<b>8. PROCURING ENTITY’S RESPONSIBILITIES.....</b>	<b>48</b>
<b>9. PRICES .....</b>	<b>48</b>
<b>10. PAYMENT.....</b>	<b>49</b>
<b>11. ADVANCE PAYMENT AND TERMS OF PAYMENT .....</b>	<b>49</b>
<b>12. TAXES AND DUTIES.....</b>	<b>50</b>
<b>13. PERFORMANCE SECURITY .....</b>	<b>50</b>
<b>14. USE OF CONTRACT DOCUMENTS AND INFORMATION.....</b>	<b>51</b>
<b>15. STANDARDS.....</b>	<b>51</b>
<b>16. INSPECTION AND TESTS.....</b>	<b>51</b>
<b>17. WARRANTY.....</b>	<b>52</b>
<b>18. DELAYS IN THE SUPPLIER’S PERFORMANCE .....</b>	<b>53</b>
<b>19. LIQUIDATED DAMAGES .....</b>	<b>53</b>
<b>20. SETTLEMENT OF DISPUTES .....</b>	<b>53</b>
<b>21. LIABILITY OF THE SUPPLIER.....</b>	<b>54</b>
<b>22. FORCE MAJEURE.....</b>	<b>54</b>
<b>23. TERMINATION FOR DEFAULT.....</b>	<b>54</b>
<b>24. TERMINATION FOR INSOLVENCY .....</b>	<b>55</b>
<b>25. TERMINATION FOR CONVENIENCE .....</b>	<b>55</b>
<b>26. TERMINATION FOR UNLAWFUL ACTS .....</b>	<b>56</b>
<b>27. PROCEDURES FOR TERMINATION OF CONTRACTS.....</b>	<b>56</b>
<b>28. ASSIGNMENT OF RIGHTS.....</b>	<b>57</b>

**29. CONTRACT AMENDMENT ..... 58**  
**30. APPLICATION..... 58**

## 1. Definitions

1.1. In this Contract, the following terms shall be interpreted as indicated:

- (a) “The Contract” means the agreement entered into between the Procuring Entity and the Supplier, as recorded in the Contract Form signed by the parties, including all attachments and appendices thereto and all documents incorporated by reference therein.
- (b) “The Contract Price” means the price payable to the Supplier under the Contract for the full and proper performance of its contractual obligations.
- (c) “The Goods” means all of the supplies, equipment, machinery, spare parts, other materials and/or general support services which the Supplier is required to provide to the Procuring Entity under the Contract.
- (d) “The Services” means those services ancillary to the supply of the Goods, such as transportation and insurance, and any other incidental services, such as installation, commissioning, provision of technical assistance, training, and other such obligations of the Supplier covered under the Contract.
- (e) “GCC” means the General Conditions of Contract contained in this Section.
- (f) “SCC” means the Special Conditions of Contract.
- (g) “The Procuring Entity” means the organization purchasing the Goods, as named in the **SCC**.
- (h) “The Procuring Entity’s country” is the Philippines.
- (i) “The Supplier” means the individual contractor, manufacturer distributor, or firm supplying/manufacturing the Goods and Services under this Contract and named in the **SCC**.
- (j) The “Funding Source” means the organization named in the **SCC**.
- (k) “The Project Site,” where applicable, means the place or places named in the **SCC**.
- (l) “Day” means calendar day.
- (m) The “Effective Date” of the contract will be the date of signing the contract, however the Supplier shall commence performance of its obligations only upon receipt of the Notice to Proceed and copy of the approved contract.

- (n) “Verified Report” refers to the report submitted by the Implementing Unit to the HoPE setting forth its findings as to the existence of grounds or causes for termination and explicitly stating its recommendation for the issuance of a Notice to Terminate.

## **2. Corrupt, Fraudulent, Collusive, and Coercive Practices**

2.1. Unless otherwise provided in the **SCC**, the Procuring Entity as well as the bidders, contractors, or suppliers shall observe the highest standard of ethics during the procurement and execution of this Contract. In pursuance of this policy, the Procuring Entity:

- (a) defines, for the purposes of this provision, the terms set forth below as follows:
  - (i) "corrupt practice" means behavior on the part of officials in the public or private sectors by which they improperly and unlawfully enrich themselves, others, or induce others to do so, by misusing the position in which they are placed, and it includes the offering, giving, receiving, or soliciting of anything of value to influence the action of any such official in the procurement process or in contract execution; entering, on behalf of the Government, into any contract or transaction manifestly and grossly disadvantageous to the same, whether or not the public officer profited or will profit thereby, and similar acts as provided in Republic Act 3019.
  - (ii) "fraudulent practice" means a misrepresentation of facts in order to influence a procurement process or the execution of a contract to the detriment of the Procuring Entity, and includes collusive practices among Bidders (prior to or after bid submission) designed to establish bid prices at artificial, non-competitive levels and to deprive the Procuring Entity of the benefits of free and open competition.
  - (iii) “collusive practices” means a scheme or arrangement between two or more Bidders, with or without the knowledge of the Procuring Entity, designed to establish bid prices at artificial, non-competitive levels.
  - (iv) “coercive practices” means harming or threatening to harm, directly or indirectly, persons, or their property to influence their participation in a procurement process, or affect the execution of a contract;
  - (v) “obstructive practice” is
    - (aa) deliberately destroying, falsifying, altering or concealing of evidence material to an administrative proceedings or investigation or making false statements to investigators in order to materially impede an

administrative proceedings or investigation of the Procuring Entity or any foreign government/foreign or international financing institution into allegations of a corrupt, fraudulent, coercive or collusive practice; and/or threatening, harassing or intimidating any party to prevent it from disclosing its knowledge of matters relevant to the administrative proceedings or investigation or from pursuing such proceedings or investigation; or

(bb) acts intended to materially impede the exercise of the inspection and audit rights of the Procuring Entity or any foreign government/foreign or international financing institution herein.

(b) will reject a proposal for award if it determines that the Bidder recommended for award has engaged in any of the practices mentioned in this Clause for purposes of competing for the contract.

2.2. Further the Funding Source, Borrower or Procuring Entity, as appropriate, will seek to impose the maximum civil, administrative and/or criminal penalties available under the applicable law on individuals and organizations deemed to be involved with any of the practices mentioned in **GCC** Clause 2.1(a).

### **3. Inspection and Audit by the Funding Source**

The Supplier shall permit the Funding Source to inspect the Supplier's accounts and records relating to the performance of the Supplier and to have them audited by auditors appointed by the Funding Source, if so required by the Funding Source.

### **4. Governing Law and Language**

4.1. This Contract shall be interpreted in accordance with the laws of the Republic of the Philippines.

4.2. This Contract has been executed in the English language, which shall be the binding and controlling language for all matters relating to the meaning or interpretation of this Contract. All correspondence and other documents pertaining to this Contract exchanged by the parties shall be written in English.

### **5. Notices**

5.1. Any notice, request, or consent required or permitted to be given or made pursuant to this Contract shall be in writing. Any such notice, request, or consent shall be deemed to have been given or made when received by the concerned party, either in person or through an authorized representative of the Party to whom the communication is addressed, or when sent by registered mail, telex, telegram, or facsimile to such Party at the address specified in the



SCC, which shall be effective when delivered and duly received or on the notice's effective date, whichever is later.

- 5.2. A Party may change its address for notice hereunder by giving the other Party notice of such change pursuant to the provisions listed in the SCC for GCC Clause 5.1.

## **6. Scope of Contract**

- 6.1. The Goods and Related Services to be provided shall be as specified in Section VI. Schedule of Requirements.
- 6.2. This Contract shall include all such items, although not specifically mentioned, that can be reasonably inferred as being required for its completion as if such items were expressly mentioned herein. Any additional requirements for the completion of this Contract shall be provided in the SCC.

## **7. Subcontracting**

- 7.1. Subcontracting of any portion of the Goods, if allowed in the **BDS**, does not relieve the Supplier of any liability or obligation under this Contract. The Supplier will be responsible for the acts, defaults, and negligence of any subcontractor, its agents, servants or workmen as fully as if these were the Supplier's own acts, defaults, or negligence, or those of its agents, servants or workmen.
- 7.2. If subcontracting is allowed, the Supplier may identify its subcontractor during contract implementation. Subcontractors disclosed and identified during the bidding may be changed during the implementation of this Contract. In either case, subcontractors must submit the documentary requirements under **ITB** Clause 12 and comply with the eligibility criteria specified in the BDS. In the event that any subcontractor is found by the Procuring Entity to be ineligible, the subcontracting of such portion of the Goods shall be disallowed.

## **8. Procuring Entity's Responsibilities**

- 8.1. Whenever the performance of the obligations in this Contract requires that the Supplier obtain permits, approvals, import, and other licenses from local public authorities, the Procuring Entity shall, if so needed by the Supplier, make its best effort to assist the Supplier in complying with such requirements in a timely and expeditious manner.
- 8.2. The Procuring Entity shall pay all costs involved in the performance of its responsibilities in accordance with **GCC** Clause 6.

## **9. Prices**

- 9.1. For the given scope of work in this Contract as awarded, all bid prices are considered fixed prices, and therefore not subject to price escalation during contract implementation, except under extraordinary circumstances and upon

prior approval of the GPPB in accordance with Section 61 of R.A. 9184 and its IRR or except as provided in this Clause.

- 9.2. Prices charged by the Supplier for Goods delivered and/or services performed under this Contract shall not vary from the prices quoted by the Supplier in its bid, with the exception of any change in price resulting from a Change Order issued in accordance with **GCC** Clause 29.

## **10. Payment**

- 10.1. Payments shall be made only upon a certification by the HoPE to the effect that the Goods have been rendered or delivered in accordance with the terms of this Contract and have been duly inspected and accepted. Except with the prior approval of the President no payment shall be made for services not yet rendered or for supplies and materials not yet delivered under this Contract. Ten percent (10%) of the amount of each payment shall be retained by the Procuring Entity to cover the Supplier's warranty obligations under this Contract as described in **GCC** Clause 17.
- 10.2. The Supplier's request(s) for payment shall be made to the Procuring Entity in writing, accompanied by an invoice describing, as appropriate, the Goods delivered and/or Services performed, and by documents submitted pursuant to the **SCC** provision for **GCC** Clause 6.2, and upon fulfillment of other obligations stipulated in this Contract.
- 10.3. Pursuant to **GCC** Clause 10.2, payments shall be made promptly by the Procuring Entity, but in no case later than sixty (60) days after submission of an invoice or claim by the Supplier. Payments shall be in accordance with the schedule stated in the **SCC**.
- 10.4. Unless otherwise provided in the **SCC**, the currency in which payment is made to the Supplier under this Contract shall be in Philippine Pesos.
- 10.5. Unless otherwise provided in the **SCC**, payments using Letter of Credit (LC), in accordance with the Guidelines issued by the GPPB, is allowed. For this purpose, the amount of provisional sum is indicated in the **SCC**. All charges for the opening of the LC and/or incidental expenses thereto shall be for the account of the Supplier.

## **11. Advance Payment and Terms of Payment**

- 11.1. Advance payment shall be made only after prior approval of the President, and shall not exceed fifteen percent (15%) of the Contract amount, unless otherwise directed by the President or in cases allowed under Annex "D" of RA 9184.
- 11.2. All progress payments shall first be charged against the advance payment until the latter has been fully exhausted.
- 11.3. For Goods supplied from abroad, unless otherwise indicated in the **SCC**, the terms of payment shall be as follows:

- (a) On Contract Signature: Fifteen Percent (15%) of the Contract Price shall be paid within sixty (60) days from signing of the Contract and upon submission of a claim and a bank guarantee for the equivalent amount valid until the Goods are delivered and in the form provided in Section VIII. Bidding Forms.
- (b) On Delivery: Sixty-five percent (65%) of the Contract Price shall be paid to the Supplier within sixty (60) days after the date of receipt of the Goods and upon submission of the documents (i) through (vi) specified in the SCC provision on Delivery and Documents.
- (c) On Acceptance: The remaining twenty percent (20%) of the Contract Price shall be paid to the Supplier within sixty (60) days after the date of submission of the acceptance and inspection certificate for the respective delivery issued by the Procuring Entity's authorized representative. In the event that no inspection or acceptance certificate is issued by the Procuring Entity's authorized representative within forty five (45) days of the date shown on the delivery receipt, the Supplier shall have the right to claim payment of the remaining twenty percent (20%) subject to the Procuring Entity's own verification of the reason(s) for the failure to issue documents (vii) and (viii) as described in the SCC provision on Delivery and Documents.

## **12. Taxes and Duties**

The Supplier, whether local or foreign, shall be entirely responsible for all the necessary taxes, stamp duties, license fees, and other such levies imposed for the completion of this Contract.

## **13. Performance Security**

- 13.1. Within ten (10) calendar days from receipt of the Notice of Award from the Procuring Entity but in no case later than the signing of the contract by both parties, the successful Bidder shall furnish the performance security in any the forms prescribed in the **ITB** Clause 33.2.
- 13.2. The performance security posted in favor of the Procuring Entity shall be forfeited in the event it is established that the winning bidder is in default in any of its obligations under the contract.
- 13.3. The performance security shall remain valid until issuance by the Procuring Entity of the Certificate of Final Acceptance.
- 13.4. The performance security may be released by the Procuring Entity and returned to the Supplier after the issuance of the Certificate of Final Acceptance subject to the following conditions:
  - (a) There are no pending claims against the Supplier or the surety company filed by the Procuring Entity;

- (b) The Supplier has no pending claims for labor and materials filed against it; and
  - (c) Other terms specified in the **SCC**.
- 13.5. In case of a reduction of the contract value, the Procuring Entity shall allow a proportional reduction in the original performance security, provided that any such reduction is more than ten percent (10%) and that the aggregate of such reductions is not more than fifty percent (50%) of the original performance security.

#### **14. Use of Contract Documents and Information**

- 14.1. The Supplier shall not, except for purposes of performing the obligations in this Contract, without the Procuring Entity's prior written consent, disclose this Contract, or any provision thereof, or any specification, plan, drawing, pattern, sample, or information furnished by or on behalf of the Procuring Entity. Any such disclosure shall be made in confidence and shall extend only as far as may be necessary for purposes of such performance.
- 14.2. Any document, other than this Contract itself, enumerated in **GCC** Clause 14.1 shall remain the property of the Procuring Entity and shall be returned (all copies) to the Procuring Entity on completion of the Supplier's performance under this Contract if so required by the Procuring Entity.

#### **15. Standards**

The Goods provided under this Contract shall conform to the standards mentioned in the Section VII. Technical Specifications; and, when no applicable standard is mentioned, to the authoritative standards appropriate to the Goods' country of origin. Such standards shall be the latest issued by the institution concerned.

#### **16. Inspection and Tests**

- 16.1. The Procuring Entity or its representative shall have the right to inspect and/or to test the Goods to confirm their conformity to the Contract specifications at no extra cost to the Procuring Entity. The **SCC** and Section VII. Technical Specifications shall specify what inspections and/or tests the Procuring Entity requires and where they are to be conducted. The Procuring Entity shall notify the Supplier in writing, in a timely manner, of the identity of any representatives retained for these purposes.
- 16.2. If applicable, the inspections and tests may be conducted on the premises of the Supplier or its subcontractor(s), at point of delivery, and/or at the goods' final destination. If conducted on the premises of the Supplier or its subcontractor(s), all reasonable facilities and assistance, including access to drawings and production data, shall be furnished to the inspectors at no charge to the Procuring Entity. The Supplier shall provide the Procuring Entity with results of such inspections and tests.

- 16.3. The Procuring Entity or its designated representative shall be entitled to attend the tests and/or inspections referred to in this Clause provided that the Procuring Entity shall bear all of its own costs and expenses incurred in connection with such attendance including, but not limited to, all traveling and board and lodging expenses.
- 16.4. The Procuring Entity may reject any Goods or any part thereof that fail to pass any test and/or inspection or do not conform to the specifications. The Supplier shall either rectify or replace such rejected Goods or parts thereof or make alterations necessary to meet the specifications at no cost to the Procuring Entity, and shall repeat the test and/or inspection, at no cost to the Procuring Entity, upon giving a notice pursuant to **GCC** Clause 5.
- 16.5. The Supplier agrees that neither the execution of a test and/or inspection of the Goods or any part thereof, nor the attendance by the Procuring Entity or its representative, shall release the Supplier from any warranties or other obligations under this Contract.

## **17. Warranty**

- 17.1. The Supplier warrants that the Goods supplied under the Contract are new, unused, of the most recent or current models, and that they incorporate all recent improvements in design and materials, except when the technical specifications required by the Procuring Entity provides otherwise.
- 17.2. The Supplier further warrants that all Goods supplied under this Contract shall have no defect, arising from design, materials, or workmanship or from any act or omission of the Supplier that may develop under normal use of the supplied Goods in the conditions prevailing in the country of final destination.
- 17.3. In order to assure that manufacturing defects shall be corrected by the Supplier, a warranty shall be required from the Supplier for a minimum period specified in the **SCC**. The obligation for the warranty shall be covered by, at the Supplier's option, either retention money in an amount equivalent to at least one percent (1%) of every progress payment, or a special bank guarantee equivalent to at least one percent (1%) of the total Contract Price or other such amount if so specified in the **SCC**. The said amounts shall only be released after the lapse of the warranty period specified in the **SCC**; provided, however, that the Supplies delivered are free from patent and latent defects and all the conditions imposed under this Contract have been fully met.
- 17.4. The Procuring Entity shall promptly notify the Supplier in writing of any claims arising under this warranty. Upon receipt of such notice, the Supplier shall, within the period specified in the **SCC** and with all reasonable speed, repair or replace the defective Goods or parts thereof, without cost to the Procuring Entity.
- 17.5. If the Supplier, having been notified, fails to remedy the defect(s) within the period specified in **GCC** Clause 17.4, the Procuring Entity may proceed to take such remedial action as may be necessary, at the Supplier's risk and expense and without prejudice to any other rights which the Procuring Entity

may have against the Supplier under the Contract and under the applicable law.

## **18. Delays in the Supplier's Performance**

- 18.1. Delivery of the Goods and/or performance of Services shall be made by the Supplier in accordance with the time schedule prescribed by the Procuring Entity in Section VI. Schedule of Requirements.
- 18.2. If at any time during the performance of this Contract, the Supplier or its Subcontractor(s) should encounter conditions impeding timely delivery of the Goods and/or performance of Services, the Supplier shall promptly notify the Procuring Entity in writing of the fact of the delay, its likely duration and its cause(s). As soon as practicable after receipt of the Supplier's notice, and upon causes provided for under **GCC** Clause 22, the Procuring Entity shall evaluate the situation and may extend the Supplier's time for performance, in which case the extension shall be ratified by the parties by amendment of Contract.
- 18.3. Except as provided under **GCC** Clause 22, a delay by the Supplier in the performance of its obligations shall render the Supplier liable to the imposition of liquidated damages pursuant to **GCC** Clause 19, unless an extension of time is agreed upon pursuant to **GCC** Clause 29 without the application of liquidated damages.

## **19. Liquidated Damages**

Subject to **GCC** Clauses 18 and 22, if the Supplier fails to satisfactorily deliver any or all of the Goods and/or to perform the Services within the period(s) specified in this Contract inclusive of duly granted time extensions if any, the Procuring Entity shall, without prejudice to its other remedies under this Contract and under the applicable law, deduct from the Contract Price, as liquidated damages, the applicable rate of one tenth (1/10) of one (1) percent of the cost of the unperformed portion for every day of delay until actual delivery or performance. The maximum deduction shall be ten percent (10%) of the amount of contract. Once the maximum is reached, the Procuring Entity may rescind or terminate the Contract pursuant to **GCC** Clause 23, without prejudice to other courses of action and remedies open to it.

## **20. Settlement of Disputes**

- 20.1. If any dispute or difference of any kind whatsoever shall arise between the Procuring Entity and the Supplier in connection with or arising out of this Contract, the parties shall make every effort to resolve amicably such dispute or difference by mutual consultation.
- 20.2. If after thirty (30) days, the parties have failed to resolve their dispute or difference by such mutual consultation, then either the Procuring Entity or the Supplier may give notice to the other party of its intention to commence arbitration, as hereinafter provided, as to the matter in dispute, and no arbitration in respect of this matter may be commenced unless such notice is given.

- 20.3. Any dispute or difference in respect of which a notice of intention to commence arbitration has been given in accordance with this Clause shall be settled by arbitration. Arbitration may be commenced prior to or after delivery of the Goods under this Contract.
- 20.4. In the case of a dispute between the Procuring Entity and the Supplier, the dispute shall be resolved in accordance with Republic Act 9285 (“R.A. 9285”), otherwise known as the “Alternative Dispute Resolution Act of 2004.”
- 20.5. Notwithstanding any reference to arbitration herein, the parties shall continue to perform their respective obligations under the Contract unless they otherwise agree; and the Procuring Entity shall pay the Supplier any monies due the Supplier.

## **21. Liability of the Supplier**

- 21.1. The Supplier’s liability under this Contract shall be as provided by the laws of the Republic of the Philippines, subject to additional provisions, if any, set forth in the SCC.
- 21.2. Except in cases of criminal negligence or willful misconduct, and in the case of infringement of patent rights, if applicable, the aggregate liability of the Supplier to the Procuring Entity shall not exceed the total Contract Price, provided that this limitation shall not apply to the cost of repairing or replacing defective equipment.

## **22. Force Majeure**

- 22.1. The Supplier shall not be liable for forfeiture of its performance security, liquidated damages, or termination for default if and to the extent that the Supplier’s delay in performance or other failure to perform its obligations under the Contract is the result of a *force majeure*.
- 22.2. For purposes of this Contract the terms “*force majeure*” and “fortuitous event” may be used interchangeably. In this regard, a fortuitous event or *force majeure* shall be interpreted to mean an event which the Supplier could not have foreseen, or which though foreseen, was inevitable. It shall not include ordinary unfavorable weather conditions; and any other cause the effects of which could have been avoided with the exercise of reasonable diligence by the Supplier. Such events may include, but not limited to, acts of the Procuring Entity in its sovereign capacity, wars or revolutions, fires, floods, epidemics, quarantine restrictions, and freight embargoes.
- 22.3. If a *force majeure* situation arises, the Supplier shall promptly notify the Procuring Entity in writing of such condition and the cause thereof. Unless otherwise directed by the Procuring Entity in writing, the Supplier shall continue to perform its obligations under the Contract as far as is reasonably practical, and shall seek all reasonable alternative means for performance not prevented by the *force majeure*.

## **23. Termination for Default**

- 23.1. The Procuring Entity shall terminate this Contract for default when any of the following conditions attends its implementation:
- (a) Outside of *force majeure*, the Supplier fails to deliver or perform any or all of the Goods within the period(s) specified in the contract, or within any extension thereof granted by the Procuring Entity pursuant to a request made by the Supplier prior to the delay, and such failure amounts to at least ten percent (10%) of the contract price;
  - (b) As a result of *force majeure*, the Supplier is unable to deliver or perform any or all of the Goods, amounting to at least ten percent (10%) of the contract price, for a period of not less than sixty (60) calendar days after receipt of the notice from the Procuring Entity stating that the circumstance of force majeure is deemed to have ceased; or
  - (c) The Supplier fails to perform any other obligation under the Contract.
- 23.2. In the event the Procuring Entity terminates this Contract in whole or in part, for any of the reasons provided under GCC Clauses 23 to 26, the Procuring Entity may procure, upon such terms and in such manner as it deems appropriate, Goods or Services similar to those undelivered, and the Supplier shall be liable to the Procuring Entity for any excess costs for such similar Goods or Services. However, the Supplier shall continue performance of this Contract to the extent not terminated.
- 23.3. In case the delay in the delivery of the Goods and/or performance of the Services exceeds a time duration equivalent to ten percent (10%) of the specified contract time plus any time extension duly granted to the Supplier, the Procuring Entity may terminate this Contract, forfeit the Supplier's performance security and award the same to a qualified Supplier.

## **24. Termination for Insolvency**

The Procuring Entity shall terminate this Contract if the Supplier is declared bankrupt or insolvent as determined with finality by a court of competent jurisdiction. In this event, termination will be without compensation to the Supplier, provided that such termination will not prejudice or affect any right of action or remedy which has accrued or will accrue thereafter to the Procuring Entity and/or the Supplier.

## **25. Termination for Convenience**

- 25.1. The Procuring Entity may terminate this Contract, in whole or in part, at any time for its convenience. The HoPE may terminate a contract for the convenience of the Government if he has determined the existence of conditions that make Project Implementation economically, financially or technically impractical and/or unnecessary, such as, but not limited to, fortuitous event(s) or changes in law and national government policies.
- 25.2. The Goods that have been delivered and/or performed or are ready for delivery or performance within thirty (30) calendar days after the Supplier's receipt of



Notice to Terminate shall be accepted by the Procuring Entity at the contract terms and prices. For Goods not yet performed and/or ready for delivery, the Procuring Entity may elect:

- (a) to have any portion delivered and/or performed and paid at the contract terms and prices; and/or
- (b) to cancel the remainder and pay to the Supplier an agreed amount for partially completed and/or performed goods and for materials and parts previously procured by the Supplier.

25.3. If the Supplier suffers loss in its initial performance of the terminated contract, such as purchase of raw materials for goods specially manufactured for the Procuring Entity which cannot be sold in open market, it shall be allowed to recover partially from this Contract, on a *quantum meruit* basis. Before recovery may be made, the fact of loss must be established under oath by the Supplier to the satisfaction of the Procuring Entity before recovery may be made.

## **26. Termination for Unlawful Acts**

26.1. The Procuring Entity may terminate this Contract in case it is determined *prima facie* that the Supplier has engaged, before or during the implementation of this Contract, in unlawful deeds and behaviors relative to contract acquisition and implementation. Unlawful acts include, but are not limited to, the following:

- (a) Corrupt, fraudulent, and coercive practices as defined in **ITB** Clause 3.1(a);
- (b) Drawing up or using forged documents;
- (c) Using adulterated materials, means or methods, or engaging in production contrary to rules of science or the trade; and
- (d) Any other act analogous to the foregoing.

## **27. Procedures for Termination of Contracts**

27.1. The following provisions shall govern the procedures for termination of this Contract:

- (a) Upon receipt of a written report of acts or causes which may constitute ground(s) for termination as aforementioned, or upon its own initiative, the Implementing Unit shall, within a period of seven (7) calendar days, verify the existence of such ground(s) and cause the execution of a Verified Report, with all relevant evidence attached;
- (b) Upon recommendation by the Implementing Unit, the HoPE shall terminate this Contract only by a written notice to the Supplier conveying the termination of this Contract. The notice shall state:

- (i) that this Contract is being terminated for any of the ground(s) afore-mentioned, and a statement of the acts that constitute the ground(s) constituting the same;
  - (ii) the extent of termination, whether in whole or in part;
  - (iii) an instruction to the Supplier to show cause as to why this Contract should not be terminated; and
  - (iv) special instructions of the Procuring Entity, if any.
- (c) The Notice to Terminate shall be accompanied by a copy of the Verified Report;
  - (d) Within a period of seven (7) calendar days from receipt of the Notice of Termination, the Supplier shall submit to the HoPE a verified position paper stating why this Contract should not be terminated. If the Supplier fails to show cause after the lapse of the seven (7) day period, either by inaction or by default, the HoPE shall issue an order terminating this Contract;
  - (e) The Procuring Entity may, at any time before receipt of the Supplier's verified position paper described in item (d) above withdraw the Notice to Terminate if it is determined that certain items or works subject of the notice had been completed, delivered, or performed before the Supplier's receipt of the notice;
  - (f) Within a non-extendible period of ten (10) calendar days from receipt of the verified position paper, the HoPE shall decide whether or not to terminate this Contract. It shall serve a written notice to the Supplier of its decision and, unless otherwise provided, this Contract is deemed terminated from receipt of the Supplier of the notice of decision. The termination shall only be based on the ground(s) stated in the Notice to Terminate;
  - (g) The HoPE may create a Contract Termination Review Committee (CTRC) to assist him in the discharge of this function. All decisions recommended by the CTRC shall be subject to the approval of the HoPE; and
  - (h) The Supplier must serve a written notice to the Procuring Entity of its intention to terminate the contract at least thirty (30) calendar days before its intended termination. The Contract is deemed terminated if it is not resumed in thirty (30) calendar days after the receipt of such notice by the Procuring Entity.

## **28. Assignment of Rights**

The Supplier shall not assign his rights or obligations under this Contract, in whole or in part, except with the Procuring Entity's prior written consent.

**29. Contract Amendment**

Subject to applicable laws, no variation in or modification of the terms of this Contract shall be made except by written amendment signed by the parties.

**30. Application**

These General Conditions shall apply to the extent that they are not superseded by provisions of other parts of this Contract.

## *Section V. Special Conditions of Contract*

# Special Conditions of Contract

GCC Clause	
1.1(g)	The Procuring Entity is <b>Department of Social Welfare and Development (DSWD) – Information and Communications Technology Management Service (ICTMS)</b> .
1.1(i)	The Supplier is <i>[to be inserted at the time of contract award]</i> .
1.1(j)	The Funding Source is the Government of the Philippines (GOP) through the <b>Information and Communications Technology Management Service (ICTMS) - Miscellaneous and Other Operating Expenses (MOOE)</b> Funds, in the amount of <b>Thirteen Million Three Hundred Thirty-Two Thousand Pesos (PhP 13,332,000.00)</b> .
1.1(k)	The Project site is defined in Section VI. Schedule of Requirements.
2.1	No further instructions.
5.1	<p>The Procuring Entity’s address for Notices is:</p> <p style="text-align: center;"><b>Department of Social Welfare and Development</b>            IBP Road, Constitution Hills, Quezon City            Telephone No.: (02) 931-8101 Local 122/124            Fax No.: (02) 931-6139</p> <p>The Supplier’s address for Notices is: <i>[Insert address including, name of contact, fax and telephone number]</i></p>
6.2	<p><b>Delivery and Documents –</b></p> <p>For purposes of the Contract, “EXW,” “FOB,” “FCA,” “CIF,” “CIP,” “DDP” and other trade terms used to describe the obligations of the parties shall have the meanings assigned to them by the current edition of INCOTERMS published by the International Chamber of Commerce, Paris. The Delivery terms of this Contract shall be as follows:</p> <p>The delivery terms applicable to this Contract are specified in Section VI. Schedule of Requirements. Risk and title will pass from the Supplier to the Procuring Entity upon receipt and final acceptance of the Goods at their final destination.</p> <p>Delivery of the Goods shall be made by the Supplier in accordance with the terms specified in Section VI. Schedule of Requirements. The details of shipping and/or other documents to be furnished by the Supplier are as follows:</p> <p><i>For Goods supplied from within the Philippines:</i></p> <p>Upon delivery of the Goods to the Project Site, the Supplier shall</p>

notify the Procuring Entity and present the following documents to the Procuring Entity:

- (i) Original and copies of the Supplier's invoice showing Goods' description, quantity, unit price, and total amount;
- (ii) Original and copies of delivery receipt detailing number and description of items received signed by the authorized receiving personnel;
- (iii) Original and copies of the Manufacturer's and/or Supplier's warranty certificate (if applicable); and
- (iv) Certificate of Acceptance/Inspection Report signed by the Procuring Entity's representative at the Project Site;

*For Goods supplied from abroad:*

Upon shipment, the Supplier shall notify the Procuring Entity and the insurance company by cable the full details of the shipment, including Contract Number, description of the Goods, quantity, vessel, bill of lading number and date, port of loading, date of shipment, port of discharge etc. Upon delivery to the Project Site, the Supplier shall notify the Procuring Entity and present the following documents as applicable with the documentary requirements of any letter of credit issued taking precedence:

- (i) Original and copies of the Supplier's invoice showing Goods' description, quantity, unit price, and total amount;
- (ii) Original and copies of the Manufacturer's and/or Supplier's warranty certificate;
- (iii) Delivery receipt detailing number and description of items received signed by the Procuring Entity's representative at the Project Site; and
- (iv) Certificate of Acceptance/Inspection Report signed by the Procuring Entity's representative at the Project Site;

For purposes of this Clause the Procuring Entity's Representative at the Project Site are defined in Section VI. Schedule of Requirements.

**Incidental Services –**

The Contract price for the Goods shall include the prices charged by the Supplier for incidental services and shall not exceed the prevailing rates charged to other parties by the Supplier for similar services.

**Packaging –**

The Supplier shall provide such packaging of the Goods as is required to prevent their damage or deterioration during transit to their final

destination, as indicated in this Contract. The packaging shall be sufficient to withstand, without limitation, rough handling during transit and exposure to extreme temperatures, salt and precipitation during transit, and open storage. Packaging case size and weights shall take into consideration, where appropriate, the remoteness of the GOODS' final destination and the absence of heavy handling facilities at all points in transit.

**Insurance –**

The Goods supplied under this Contract shall be fully insured by the Supplier in a freely convertible currency against loss or damage incidental to manufacture or acquisition, transportation, storage, and delivery. The Goods remain at the risk and title of the Supplier until their final acceptance by the Procuring Entity.

**Transportation –**

Where the Supplier is required under Contract to deliver the Goods CIF, CIP or DDP, transport of the Goods to the port of destination or such other named place of destination in the Philippines, as shall be specified in this Contract, shall be arranged and paid for by the Supplier, and the cost thereof shall be included in the Contract Price.

Where the Supplier is required under this Contract to transport the Goods to a specified place of destination within the Philippines, defined as the Project Site, transport to such place of destination in the Philippines, including insurance and storage, as shall be specified in this Contract, shall be arranged by the Supplier, and related costs shall be included in the Contract Price.

Where the Supplier is required under Contract to deliver the Goods CIF, CIP or DDP, Goods are to be transported on carriers of Philippine registry. In the event that no carrier of Philippine registry is available, Goods may be shipped by a carrier which is not of Philippine registry provided that the Supplier obtains and presents to the Procuring Entity certification to this effect from the nearest Philippine consulate to the port of dispatch. In the event that carriers of Philippine registry are available but their schedule delays the Supplier in its performance of this Contract the period from when the Goods were first ready for shipment and the actual date of shipment the period of delay will be considered *force majeure* in accordance with GCC Clause 22.

The Procuring Entity accepts no liability for the damage of Goods during transit other than those prescribed by INCOTERMS for DDP Deliveries. In the case of Goods supplied from within the Philippines or supplied by domestic Suppliers risk and title will not be deemed to have passed to the Procuring Entity until their receipt and final

	<p>acceptance at the final destination.</p> <p><b>Patent Rights –</b></p> <p>The Supplier shall indemnify the Procuring Entity against all third-party claims of infringement of patent, trademark, or industrial design rights arising from use of the Goods or any part thereof.</p>
10.4	Not applicable.
10.5	Payment using LC is not allowed.
11.3	<p>Payment shall be made quarterly after managed network services has been rendered (25% of the total contract price every quarter).</p> <p>Payment shall be made after every third (3<sup>rd</sup>) month of the quarter and completion of all supporting documents (e.g. inspection reports, delivery receipts, etc.).</p>
13.4(c)	No further instructions.
16.1	The DSWD-Inspection Committee, in cooperation with the Information and Communication Technology Management Service (ICTMS), shall inspect the goods upon delivery and conduct tests for the compliance with the required technical specifications.
17.3	<p>Warranty:</p> <ul style="list-style-type: none"> <li>- Structured Cabling System: 3 years;</li> </ul> <p>Service Level Agreement (SLA):</p> <ul style="list-style-type: none"> <li>- Network devices should be up 24/7;</li> <li>- Initial response time via SMS, Call, or Email shall be 30 minutes after the issue is reported/raised;</li> <li>- Issue resolution (issues that require remote assistance) shall be a maximum of 4 hours;</li> <li>- Response time for on-site support shall be Next Business Day after the issue is reported/raised; and,</li> <li>- Hardware replacement shall be Next Business Day.</li> </ul>
17.4	The period for correction of defects in the warranty period is seven (7) calendar days.
21.1	All partners to the joint venture shall be jointly and severally liable to the Procuring Entity.



## *Section VI. Schedule of Requirements*

### **Subscription of Local Area Network Services for DSWD Central Office New Building**

Particulars	Components	Quantity
Subscription of Local Area Network Services for DSWD Central Office New Building	Fiber Optic Backbone	400 meters
	Distribution Switch	4 units
	Access Switch	14 units
	Wireless Controller	1 unit
	Wireless Access Point	21 units
	Network Nodes	489 units
	PRTG License	1 unit
	UPS	1 unit

#### **Timeline/ Schedule of Deliverables:**

- Supply, Delivery, Installation, Testing and User Acceptance – Within sixty (60) calendar days upon receipt of Notice to Proceed (NTP)

Deliverables	Timelines
Submission and Approval of Project Implementation Plan	5 calendar days
Supply, Delivery, and Installation of Fiber Optic Backbones and Structured Cabling	50 calendar days
Supply, Delivery, and Installation of Fiber Optic of Network Switches	50 calendar days
Supply, Delivery, and Installation of Wireless Access Points	50 calendar days
Testing and User Acceptance	5 calendar days
Submission of Project Documentations	5 calendar days

#### **Terms of Payment:**

- Payment shall be made quarterly after managed network services has been rendered (25% of the total contract price every quarter).
- Payment shall be made after every third (3<sup>rd</sup>) month of the quarter and completion of all supporting documents (e.g. inspection reports, delivery receipts, etc.).

**Delivery Site\*:**

DSWD Central Office-Procurement Management Service

**c/o MS. GENIELA I. SOLEDAD**

Administrative Assistant III

Contract Monitoring Division-Procurement Management Service

DSWD Central Office

IBP Road, Batasan Complex, Constitution Hills, Quezon City

*\* in coordination with ICTMS*

Name of Bidder: \_\_\_\_\_

Name of Authorized Representative: \_\_\_\_\_

Signature of Authorized Representative: \_\_\_\_\_

Date: \_\_\_\_\_

**\*\*\*THIS DOCUMENT MUST BE ATTACHED TO THE  
TECHNICAL SPECIFICATIONS\*\*\***

## ***Section VII. Technical Specifications***

# Technical Specifications

DSWD Specifications	Bidder’s Specifications <sup>4</sup>
<p><b>Subscription to Local Area Network Services for DSWD Central Office New Building</b></p> <p><b>1. Managed Local Area Network Services Coverage</b></p> <p>1.1. The Service Provider shall provide free use of structured cabling system and 10gbps fiber optic backbones connecting Matapat Datacenter to the first floor IDF of the new building. Backbones of the 2nd, 3rd, and 4th IDFs should also be 10gbps and shall be connected to the 1st floor IDF. Link between the access and distribution switch should also be of 10gbps</p> <p>1.2. The Service Provider shall provide free use of network devices such as enterprise-grade network switches and wireless access points</p> <p>1.3. The Service Provider shall provide free use of wireless controller to manage the wireless access points</p> <p>1.4. The Service Provider shall offer free installation, setup, configuration, integration into existing network, and technical on-site support and issue resolution</p> <p>1.4.1. Free hardware maintenance and replacement with 24/7 support</p> <p>1.4.2. Continuous subscription to firmware and software updates</p>	<p>Brand:</p> <p>Model:</p> <p>Detailed Specifications:</p>

---

<sup>4</sup> **IMPORTANT NOTE:** Detailed specifications must be provided. Statements of “Comply” or “Not Comply” must be supported by evidence in a Bidders Bid and cross-referenced to that evidence. Evidence shall be in the form of manufacturer’s un-amended sales literature, unconditional statements of specification and compliance issued by the manufacturer, samples, independent test data etc., as appropriate. A statement that is not supported by evidence or is subsequently found to be contradicted by the evidence presented will render the Bid under evaluation liable for rejection. A statement either in the Bidders statement of compliance or the supporting evidence that is found to be false either during Bid evaluation, post-qualification or the execution of the Contract may be regarded as fraudulent and render the Bidder or supplier liable for prosecution subject to the provisions of **ITB** Clause 3.1(a)(ii) and/or **GCC** Clause 2.1(a)(ii).

<p>1.4.3. Access to technical support, online resources, and portals</p> <p>1.4.4. Avail of an onsite support from certified network engineers for faster issue resolution</p> <p>1.5. The Service Provider shall managed all the active components of the project such as switches, access points and wireless controller</p> <p>1.6. The Service Provider shall conduct quarterly network assessment with recommendations. These recommendations shall be implemented by the provider once approved by the Network Group of DSWD</p> <p>1.7. The Service Provider shall capacitate the network engineers of DSWD Central Office by providing certification and technology transfer trainings</p> <p>1.8. The Service Provider shall ensure that the following Service Level Agreement is achieved:</p> <p>1.8.1. Network devices should be up 24/7</p> <p>1.8.2. Initial response time via SMS, Call, or Email shall be 30 minutes after the issue is reported/raised</p> <p>1.8.3. Issue resolution (issues that require remote assistance) shall be a maximum of 4 hours</p> <p>1.8.4. Response time for on-site support shall be Next Business Day after the issue is reported/raised</p> <p>1.8.5. Hardware replacement shall be Next Business Day</p> <p><b>2. Technical Specifications</b></p> <p><b>2.1. Structured Cabling System</b></p> <p>2.1.1. The Service Provider shall provide Structured Cabling System service with the following fiber optic backbones and number of nodes:</p>	
--	--

Table 1. Length of Fiber Optic Backbones and Number of Network Nodes:

IDF	Distance of IDF from Ground Floor	Number of Nodes
Matapat NOC	300 meters	<i>none</i>
First Floor IDF	<i>none</i>	140
Second Floor IDF	25 meters	236
Third Floor IDF	35 meters	99
Fourth Floor IDF	40 meters	14

2.1.2. The above measurements are just estimates. If the said estimates will not suffice during the implementation, the service provider should provide the additional fiber optic cables.

2.1.3. All network cables shall be properly terminated, tagged, documented, and tested using a certified cable tester to obtain accurate results

2.1.4. The Service Provider shall provide and install the 42 RU Data Cabinets in their proposed locations

2.1.5. All structured cabling system materials needed for the installation of the wireless shall be provided and installed by the Service Provider

2.1.6. Installation shall include all civil works and labor for the cabling, demolition, excavation, and restoration of walls, floors, and other physical changes in the buildings or campus

2.1.7. All cabling installations shall be done under the direct supervision of a Certified Structured Cabling Installer.

2.1.8. The following industry standards, guidelines, and methodologies must be strictly followed by the Service Provider who designs, specifies, installs, and

manages the installation of Structured Cabling System

2.1.9. Structured cabling system warranty shall be 3 years.

2.1.9.1. American National Standards Institute (ANSI) / Telecommunications Industry Association (TIA) / Electronics Industries Association (EIA) – ANSI/ TIA/ EIA-568-B.1- Commercial Building Telecommunications Wiring Standard

2.1.9.2. ANSI/ TIA/ EIA-TSB67- Transmission Performance Specification for Field Testing of UTP Cabling Systems

2.1.9.3. ANSI/ TIA/ EIA-TSB72 - Centralized Optical Fiber Cabling Guidelines

2.1.9.4. ANSI/ TIA/ EIA-569-A - Commercial Building Standard for Telecommunications Pathways and Spaces

2.1.9.5. ANSI/ TIA/ EIA-455-6 - FOTB-61 - Measurement of Fiber or Cable Attenuation Using an OTDR

2.1.9.6. ISO/ IEC 11801 – Information Technology – Generic Cabling for Customer Premise

**2.2. Network Switches**

2.2.1. The Service Provider shall supply, deliver, install, and configure the following network switches in the following locations:

IDF	Distribution	Access
1st Floor IDF	1	4
2nd Floor IDF	1	6
3rd Floor IDF	1	3

4th Floor IDF	1	1	<p>2.2.2. The Service Provider shall provide Multi-mode SFP+ transceivers for distribution and access switches</p> <p>2.2.3. The Service Provider shall provide one (1) RS232 to USB and one (1) Serial Cable per Field Office for management of the network devices</p> <p><b>2.2.4. Distribution Switch</b></p> <p>2.2.4.1. I/O ports and slots: 24 SFP+ ports; 1 RJ-45 serial console port, 1 RJ-45 out-of-band management port</p> <p>2.2.4.2. Power supply: <math>\geq 2</math> power supply required</p> <p>2.2.4.3. Fan Tray: 1 unit fan tray</p> <p>2.2.4.4. Inclusive of SFP+ /10GbE transceivers</p> <p>2.2.4.5. Performance: Throughput: <math>\geq 285</math> Mbps; Routing /Switching: <math>\geq 480</math> Gbps; Fabric Speed: <math>\geq 508</math> Gbps</p> <p>2.2.4.6. Features:</p> <p><b>2.2.4.6.1.</b> Supports OpenFlow 1.0 and 1.3 or NETCONF or equivalent industry standard protocol for SDN</p> <p><b>2.2.4.6.2.</b> Quality of Service (QoS) - Advanced classifier-based QoS, Layer 4 prioritization, Class of Service (CoS), Bandwidth shaping, Remote Monitoring (RMON), sFlow v5, and Traffic prioritization</p> <p><b>2.2.4.6.3.</b> Management - IEEE 802.1AB Link Layer Discovery Protocol (LLDP), Multiple configuration files, Out-of-band Ethernet management port, Zero-Touch Provisioning (ZTP), Device Link Detection Protocol(DLDP)</p>
---------------	---	---	---



or equivalent

- 2.2.4.6.4.** Connectivity - Jumbo frames, SFP+ uplink, IPv6 , IPv6 routing support, Auto-MDIX
- 2.2.4.6.5.** Resiliency and High Availability - Virtual Router Redundancy Protocol (VRRP), IEEE 802.3ad Link Aggregation Protocol (LACP), IEEE 802.1s Multiple Spanning Tree, Hot-swappable power supplies
- 2.2.4.6.6.** Layer 2 Switching - IEEE 802.1ad QinQ, VLAN support and tagging, Secure Sockets Layer (SSL), Port security
- 2.2.4.6.7.** Layer 3 Services - Loopback interface address, Route maps, DHCP server, and Bidirectional Forwarding Detection (BFD)
- 2.2.4.6.8.** Layer 3 routing - Static IP routing, Policy-based routing, Border Gateway Protocol (BGP), OSPF, Routing Information Protocol (RIP) v1, v2 & RIPng
- 2.2.4.6.9.** Security - Control Plane Policy, Source-port filtering, RADIUS/TACACS+, Secure FTP, Dynamic IP lockdown, Dynamic ARP protection, STP root guard, ACL, IEEE 802.1X authentication, Web-based authentication, MAC-based authentication, Switch CPU protection, Private VLAN protection, Open Authentication Role, and Critical Authentication Role
- 2.2.4.6.10.** Convergence - IP multicast snooping (data-driven IGMP), LLDP-MED (Media Endpoint Discovery), PoE allocations, Protocol Independent Multicast

for IPv6, IP multicast routing,  
RADIUS VLAN configuration,  
Local MAC Authentication

### **2.2.5. Access Switch**

2.2.5.1. Ports: 44 RJ-45 autosensing  
10/100/1000 ports; 4 SFP+ Ports, 1  
Dual Personality serial console port;  
1 USB B port for uploading/  
downloading files; 1 100BASE-T  
Out of Band Management Port

2.2.5.2. Power Supply:  $\geq 2$  power supply  
required

2.2.5.3. Performance: Throughput:  $\geq 112$   
Mpps, Switching capacity:  $\geq 176$   
Gbps

2.2.5.4. Inclusive of SFP+ /10GbE  
Transceiver

2.2.5.5. Features:

**2.2.5.5.1.** Supports OpenFlow 1.0 and 1.3  
or NETCONF or equivalent  
industry standard protocol for  
SDN

**2.2.5.5.2.** Quality of service (QoS): L4  
prioritization, Class of service  
(CoS), Remote monitoring  
(RMON), and sFlow

**2.2.5.5.3.** Connectivity -Auto-MDIX,  
IEEE 802.3at Power over  
Ethernet (PoE+), IPV6 Routing

**2.2.5.5.4.** Performance - Selectable queue  
configuration, Stacking topology

**2.2.5.5.5.** Convergence - IEEE 802.1AB  
Link Layer Discovery Protocol  
(LLDP)

**2.2.5.5.6.** Resiliency and high availability:  
IEEE 802.3ad Link-  
Aggregation-Control Protocol  
(LACP) and port trunking,  
Multiple Spanning Tree Protocol  
(STP), Virtual Router

Redundancy Protocol (VRRP)

**2.2.5.5.7.** L2 switching: VLAN support and tagging,, Jumbo Packets

**2.2.5.5.8.** L3 services: Loopback interface address, Route maps

**2.2.5.5.9.** L3 routing: RIPv1 and v2, Static IP routing, OSPF, Policy-based routing, IPv4 border gateway routing protocol

**2.2.5.5.10.** Security: Source-port filtering, RADIUS/TACACS+, Secure shell (SSH), Secure Sockets Layer (SSL), Port security, MAC address lockout, STP bridge protocol data units (BPDUs) port protection, DHCP protection, STP root guard, ACLs, IEEE 802.1X, Web and MAC-based authentication

**2.2.5.5.11.** Supports Energy-efficient Ethernet (80 PLUS, Silver Certified)

**2.3. Wireless Access Points and Wireless Controller**

2.3.1. The Service Provider shall supply, deliver, install, and configure the following wireless controller and access points in the following locations:

Table 3: Number of Wireless Controller and Wireless Access Points

IDF	Access Points	Controller
1st Floor IDF	5	1
2nd Floor IDF	5	
3rd Floor IDF	5	
4th Floor IDF	6	

<p><b>2.3.2. Wireless Controller</b></p> <p>2.3.2.1. AP capacity: The controller must be able to handle maximum 64 AP</p> <p>2.3.2.2. Concurrent device connected: The controller must be capable of maximum 4,096 concurrent users</p> <p>2.3.2.3. Concurrent GRE Tunnels: The controller must have 256 concurrent GRE tunnels</p> <p>2.3.2.4. Concurrent IPsec sessions: The controller must have 1,000 concurrent sessions</p> <p>2.3.2.5. Wired throughput: The controller must have 4.0 Gbps for supporting large packets</p> <p>2.3.2.6. VLAN support: The controller must support VLAN tagging with maximum of 4,094 VLANS</p> <p>2.3.2.7. Interfaces: The controller must have at least 4 auto-negotiating 10/100/1000BASE-T ports</p> <p>2.3.2.8. Integration to Role Based Feature: The controller must support policy enforcement function, that can be loaded on the controller</p> <p>2.3.2.9. Integration with IDS / IPS function: The controller must support RF protection feature that that can be loaded optional on the controller</p> <p>2.3.2.10. Common Features: The controller must have common features like: Guest Portal, AP Provision, Group Manage</p> <p>2.3.2.11. Controller Architecture: The controller can be deployed via following architecture:</p> <p>2.3.2.11.1. Master Controller – This controller manages local controllers, either in the same campus or in remote sites</p>	
---	--

2.3.2.11.2. Local Controller – Global settings for this controller are managed by a Master Controller

2.3.2.11.3. Standalone – This controller operates independently within the network

2.3.2.12. VPN Function: The controller must support remote AP function where the AP will communicate via IPsec to the controller and be able to forward all role based function to the AP. The controller must support concurrent 4,096 IPsec sessions

2.3.2.13. AP License: The AP license shall be capable of AP management, performance management, and RF management

### 2.3.3. Wireless Access Point

2.3.3.1. Interfaces: 2x 10/100/1000BASE-T (RJ-45); USB 2.0 host interface (type A connector); Serial console interface (RJ-45)

2.3.3.2. Power supply: supports direct DC power source and Power over Ethernet (PoE)

2.3.3.3. Power over Ethernet (PoE): 802.3af /802.3at compliant source

2.3.3.4. Performance: Max data rate:  $\geq 1,733$  Mbps for 5Ghz radio  $\geq 800$  Mbps for 2.4Ghz radio; Composed of 8 integrated omni-directional downtilt antenna; software configurable dual radio support;  $\geq 255$  associated client devices per radio &  $\geq 16$  BSSIDs per radio

2.3.3.5. Features & Specifications:

**2.3.3.5.1.** Software-configurable dual radio supports up to 1,733Mbps in 5Ghz band & 800Mbps in 2.4Ghz band

**2.3.3.5.2.** Supports advanced cellular coexistence to minimize interference from 3G/4G cellular networks, distributed antenna systems, and commercial small cell /femtocell equipment

**2.3.3.5.3.** RF Management automatically assigns channel and power settings, provides airtime fairness, and ensures AP stay clear of all source of RF interference to deliver reliable, high performance WLANs

**2.3.3.5.4.** Security features such as integrated wireless intrusion protection, threat protection and mitigation, and eliminates the need for separate RF sensors & security appliances

**2.4. Upgrade of License of PRTG Network Monitor from 500 to 2500 Sensors**

**2.5. Uninterruptible Power Supply (UPS), 10kVA**

2.5.1. The Service Provider shall supply, deliver, install, and configure the UPS in the following locations. It shall include supply & installation of input & output circuit breakers, cables, lugs, conduits, fittings, and rough-ins

IDF	UPS
Ground Floor IDF	1

**2.5.2. Technical Specifications**

**2.5.2.1. Input AC**

**2.5.2.1.1.** Nominal Frequency: 50 /60Hz

**2.5.2.1.2.** Frequency Range: 40 to 70Hz

**2.5.2.1.3.** Input Voltage: 220/230/240Vac  
Single Phase

**2.5.2.1.4.** Power Factor:  $\geq 0.99$  at full load

&  $\geq 0.98$  at half load

2.5.2.2. Output AC

**2.5.2.2.1.** Nominal Frequency: 50hz/ 60Hz

**2.5.2.2.2.** Output Voltage: 220/230/240,  
Single Phase

**2.5.2.2.3.** Output power factor: Unity

2.5.2.3. Battery

**2.5.2.3.1.** Type: non-spillable, lead acid

**2.5.2.3.2.** Recharge Time:  $\leq 3$ hrs to 90%

2.5.2.4. Back-up Time:  $\geq 4$  min at full load

2.5.2.5. Installation mode: Rack mountable

2.5.3. Features and Specifications:

2.5.3.1. The UPS should have the hot swappable battery configuration

2.5.3.2. The UPS shall have built-in protection against surges, spikes, sags, outages, noise, frequency deviation, transient, under voltage, over voltage, and over current from the AC source

2.5.3.3. The UPS should have an automatic static bypass that will automatically transfer the load during UPS internal fault, overload, or temperature

2.5.3.4. The UPS should have a built-in RJ-45 port for SNMP monitoring and Web Management

2.5.3.5. The UPS should have a communication card that shall provide Web access, environmental sensor data, and third-party customer protocols for the UPS and manage a wide range of operating parameters, sending data over ethernet networks via secure HTTPS protocol and alarms and notifications via SNMP traps

<p>2.5.3.6. The UPS Management should be capable of integrating with the existing DSWD Datacenter Management console</p> <p>2.5.3.7. The UPS batteries should be suitable for high efficient discharge applications. It should support at least for more than 260 cycles at 100% discharge</p> <p>2.5.3.8. The battery cabinet of the UPS should be rack-mountable type</p> <p>2.5.3.9. The UPS LCD display</p> <p style="padding-left: 40px;"><b>2.5.3.9.1.</b> should be capable, allowing the user to operate and control the UPS checking parameters as well as UPS and battery status</p> <p style="padding-left: 40px;"><b>2.5.3.9.2.</b> should be able to store and retrieve up to 2000 events /alarm for reference and diagnosis</p> <p style="padding-left: 40px;"><b>2.5.3.9.3.</b> shall be auto-rotatable to vertical or horizontal mode and vice-versa, depending on installation method (rack or tower)</p> <p><b>3. List of Reports</b></p> <p>3.1. Service Level Agreement</p> <p>3.2. Project Documentation indicating the following:</p> <p style="padding-left: 40px;">3.2.1. Floor Plans indicating the location of fiber optic cable runs, MDFs, and IDFs</p> <p style="padding-left: 40px;">3.2.2. Test results indicating test parameters such as Wire Map, Length, Propagation Delay, Delay Skew, Insertion Loss, Return Loss, and Attenuation to Crosstalk ratio</p> <p style="padding-left: 40px;">3.2.3. Node Mapping (Distribution Switch – Access Switch – Wireless Access Point - Location)</p> <p style="padding-left: 40px;">3.2.4. Installation pictures</p>	
--	--



**4. Qualification of Service Provider**

- 4.1. The Service Provider should have done at least five (5) successful projects involving the quoted service with certifications and proof of satisfactory service from previous or existing clients
- 4.2. The offered brand should be an international brand, and should have been continuously marketed in the Philippines for the last 10 years
- 4.3. The Service Provider should have been in the business of providing networking services and structured cabling system for the last 10 years
- 4.4. The Service Provider should have certified Engineers of the offered brand both network equipment and cabling
- 4.5. The Service Provider should have a Project Manager who is a Project Management Professional (PMP) certified and have 5 years of project management experience on network infrastructure and services

# Annex A. Floor Plan

## DSWD CENTRAL OFFICE 4 Storey Bldg. Ground Flr Proposed Network Nodes

### Proposed Requirements

- 140 - Network Nodes
- 1 - DSW, 48 ports
- 6 - ASW, 24 ports
- 5 - WAP
- 1 - Ups, 10kva
- 1 - FOC Patch Panel
- 2 - SC-LC (panel-xceiver), 2mtrs
- 1 - Transceiver(10g)
- 1 - Transceiver(1g)
- 1 - IDF, 42u

### LEGEND

-  PROPOSED NODE
-  PROPOSED WAP
-  PROPOSED DATA CABINET

### OBSUs

- Admin Service - 15
- AS PAD - 35
- FMS - 15
- FMS FCD - 35
- AS PAMD - 35
- Sec Info / Lobby - 5

### Note:

\*Proper/Fixed location for proposed Data Cabinet, WAP & Network Nodes, will be identified by ICTMS-NTSSD Network Group

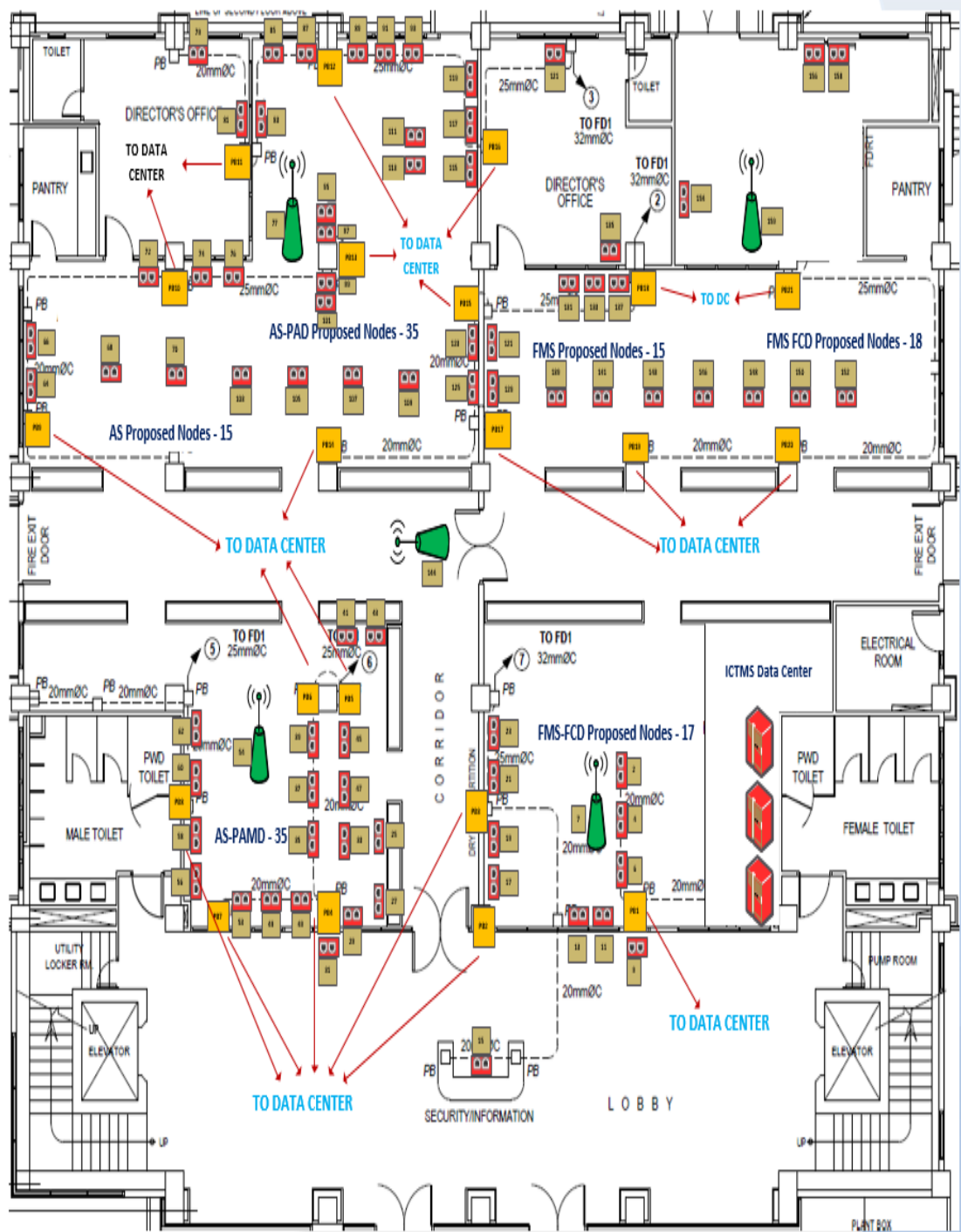

# DSWD CENTRAL OFFICE 4 Storey Bldg. 2nd floor Proposed Network Nodes

## Proposed Requirements

- 236 - Network Nodes
- 1 - DSU, 48 ports
- 10 - ASW, 24 ports
- 5 - WAP
- 1 - Ups, 2kva
- 1 - FOC Patch Panel
- 2 - SC-LC (panel-xcvr), 2mtrs
- 1 - Transceiver(10g)
- 1 - Transceiver(1g)
- 1 - IDF, 42u

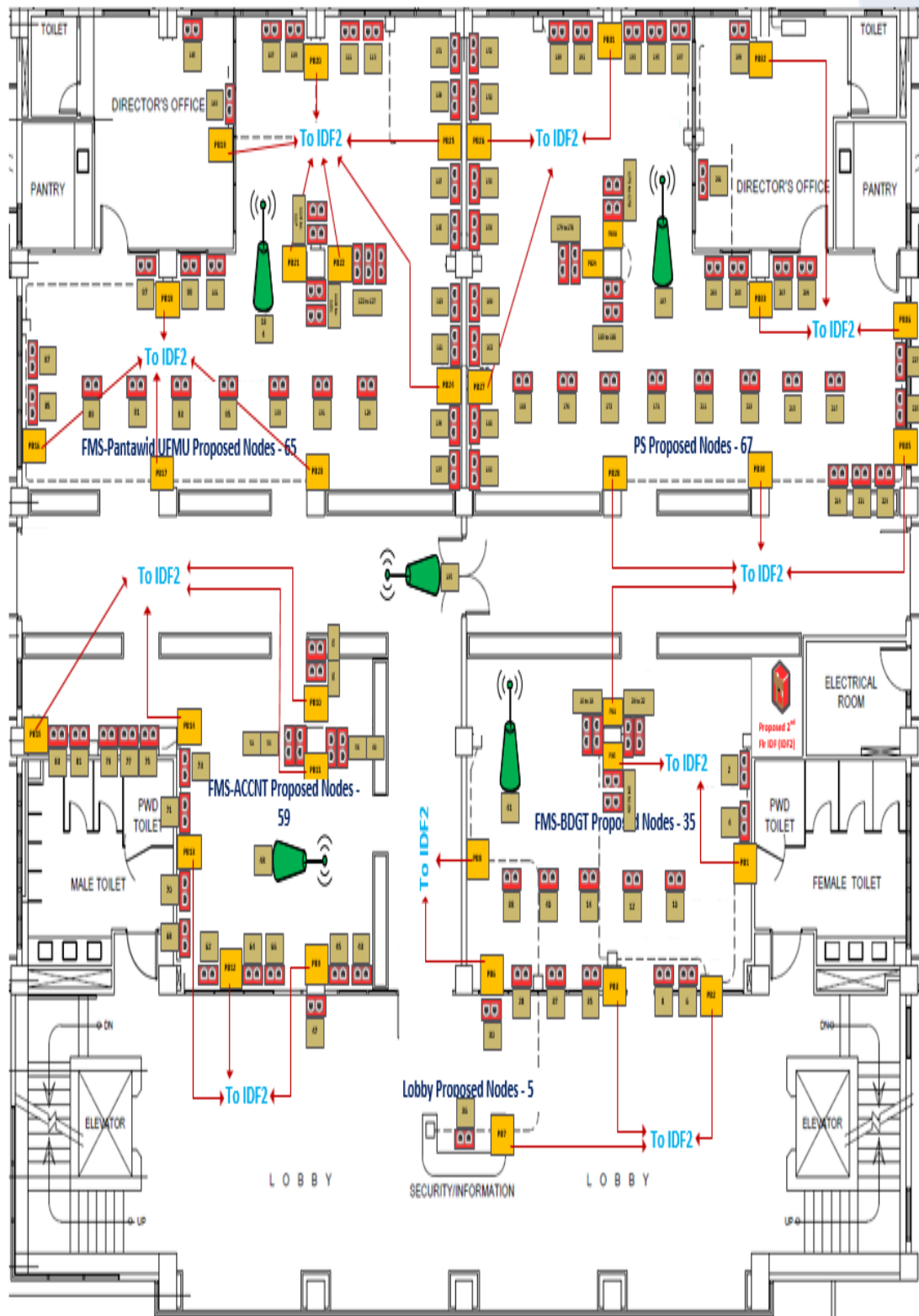

## LEGEND

- PROPOSED NODE
- PROPOSED WAP
- PROPOSED DATA CABINET

## OBSUs

- FMS Pantawid - 65
- PS - 67
- FMS Acctng - 59
- FMS Budget - 35
- Sec Info / Lobby - 5

## Note:



\*Proper/Fixed location for proposed Data Cabinet, WAP & Network Nodes, will be identified by ICTMS-NTSSD Network Group

# DSWD CENTRAL OFFICE 4 Storey Bldg. 3rd floor Proposed Network Nodes

## Proposed Requirements

- 99 - Network Nodes
- 1 - DSU, 48 ports
- 4 - ASW, 24 ports
- 5 - WAP
- 1 - Ups, 2kva
- 1 - FOC Patch Panel
- 2 - SC-LC (panel-xceiver), 2mtrs
- 1 - Transceiver(10g)
- 1 - Transceiver(1g)
- 1 - IDF, 42u

## LEGEND

-  PROPOSED NODE
-  PROPOSED WAP
-  PROPOSED DATA CABINET

## OBSUs

- OASGASSG - 15
  - NROO WMDFD - 10
  - OUSGASSG - 21
  - LS - 21
  - NROO - 22
  - Sec Info / Lobby - 5
- Note:

\*Proper/Fixed location for proposed Data Cabinet, WAP & Network Nodes, will be identified by ICTMS-NTSSD Network Group

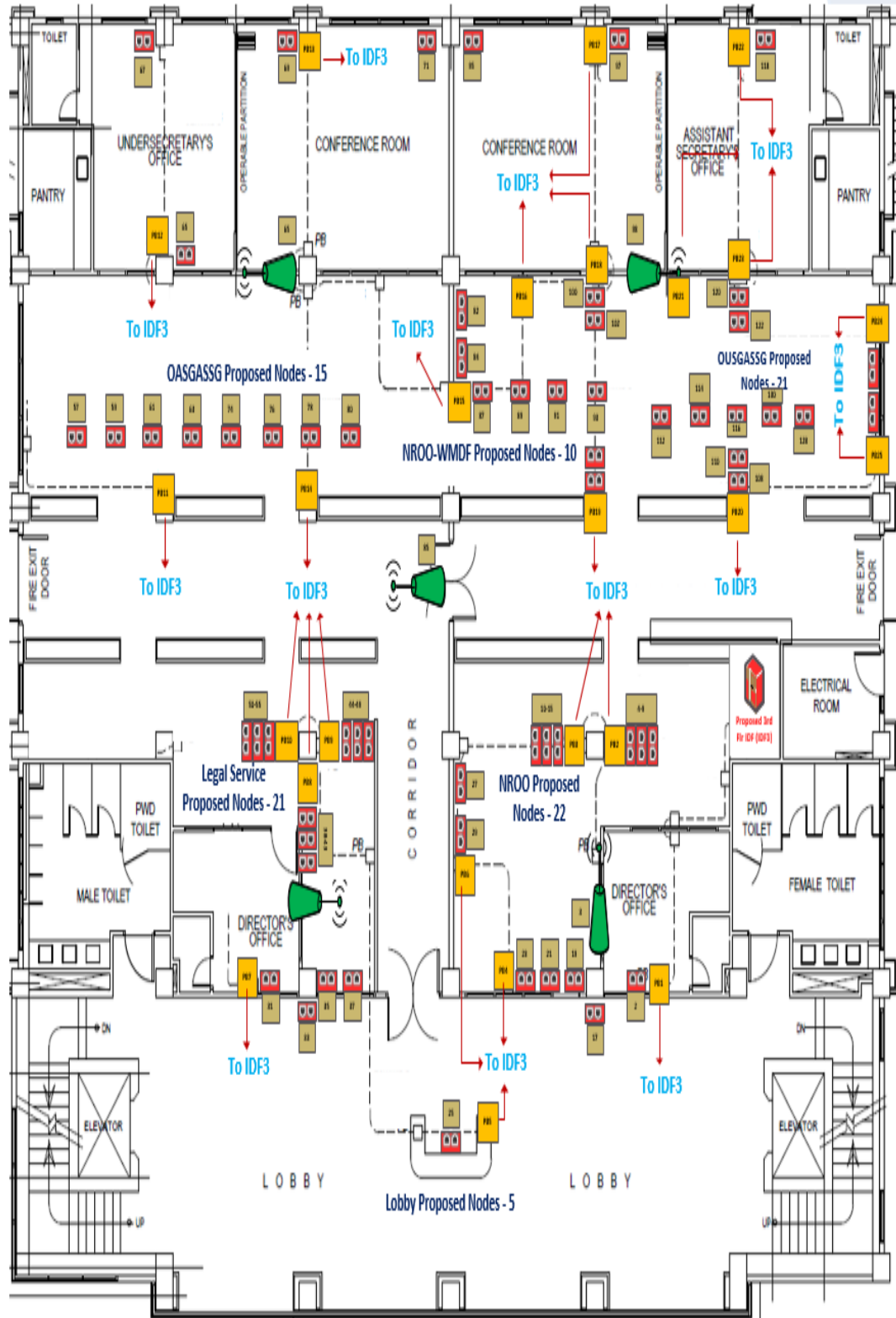

# DSWD CENTRAL OFFICE 4 Storey Bldg. 4th floor Proposed Network Nodes

## Proposed Requirements

- 14 - Network Nodes
- 1 - DSW, 48 ports
- 1 - ASW, 24 ports
- 6 - WAP
- 1 - Ups, 2kva
- 1 - FOC Patch Panel
- 2 - SC-LC (panel-receiver), 2mtrs
- 1 - Transceiver(10g)
- 1 - Transceiver(1g)
- 1 - IDF, 42u

## LEGEND

-  PROPOSED NODE
-  PROPOSED WAP
-  PROPOSED DATA CABINET

## OBSUs

- Plenary Hall - 9
- Lobby - 1

## Note:

\*Proper/Fixed location for proposed Data Cabinet, WAP & Network Nodes, will be identified by ICTMS-NTSSD Network Group

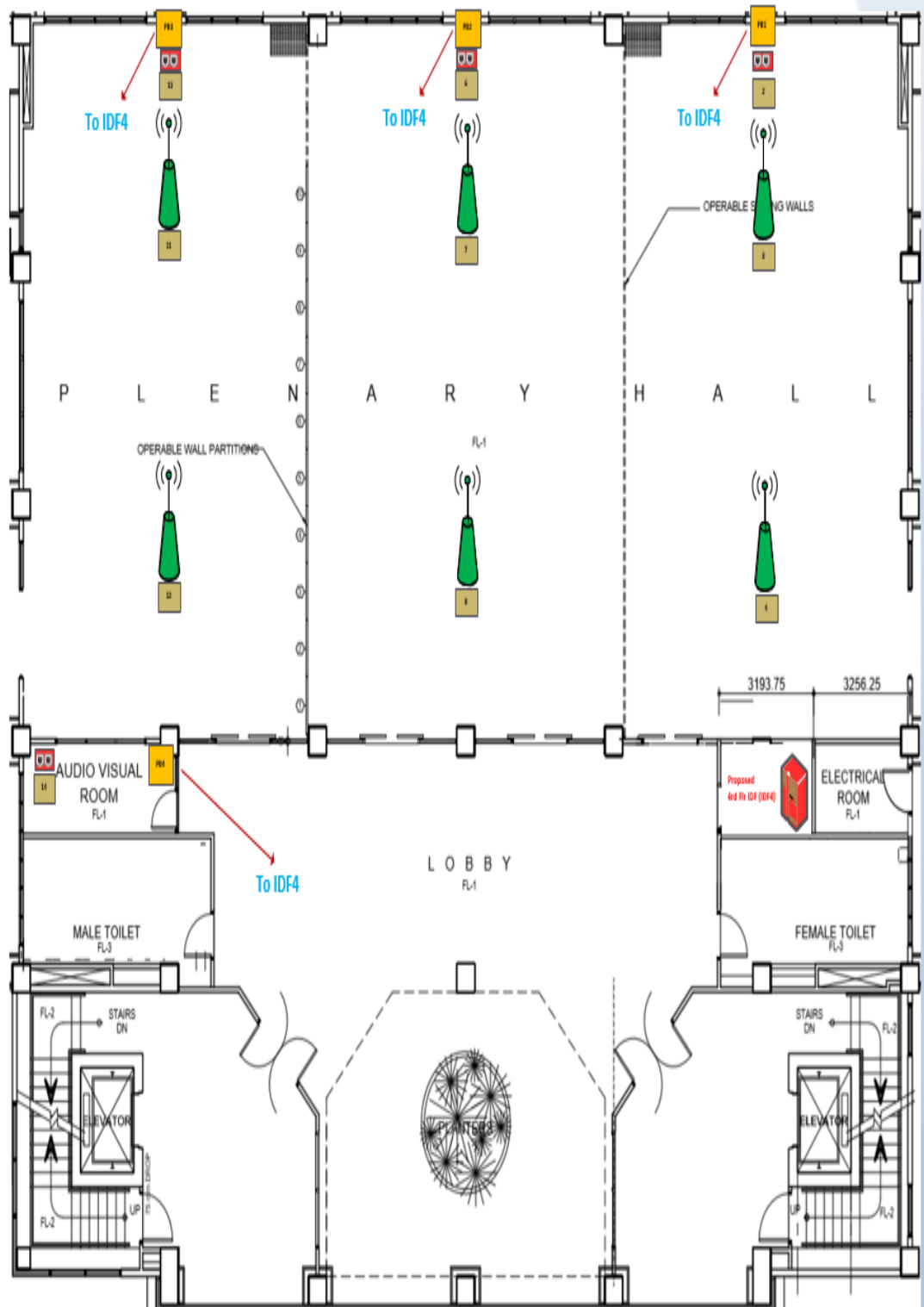

## Annex B. UPS Layout

### DSWD CENTRAL OFFICE 4 Storey Bldg. UPS Proposed Layout

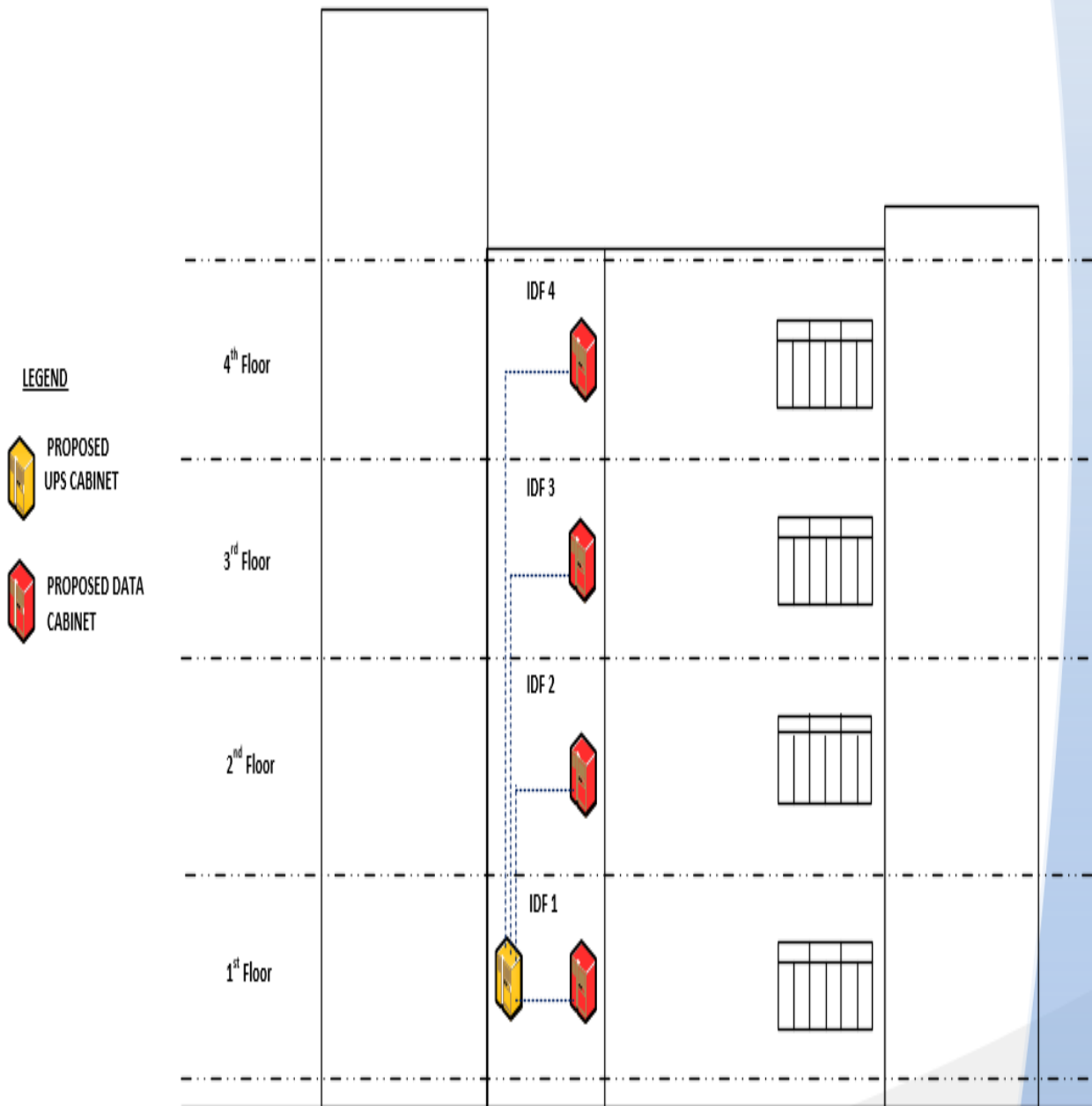

## Annex C. Fiber Backbone Layout

### DSWD CENTRAL OFFICE 4 Storey Bldg. Fiber Backbone Layout

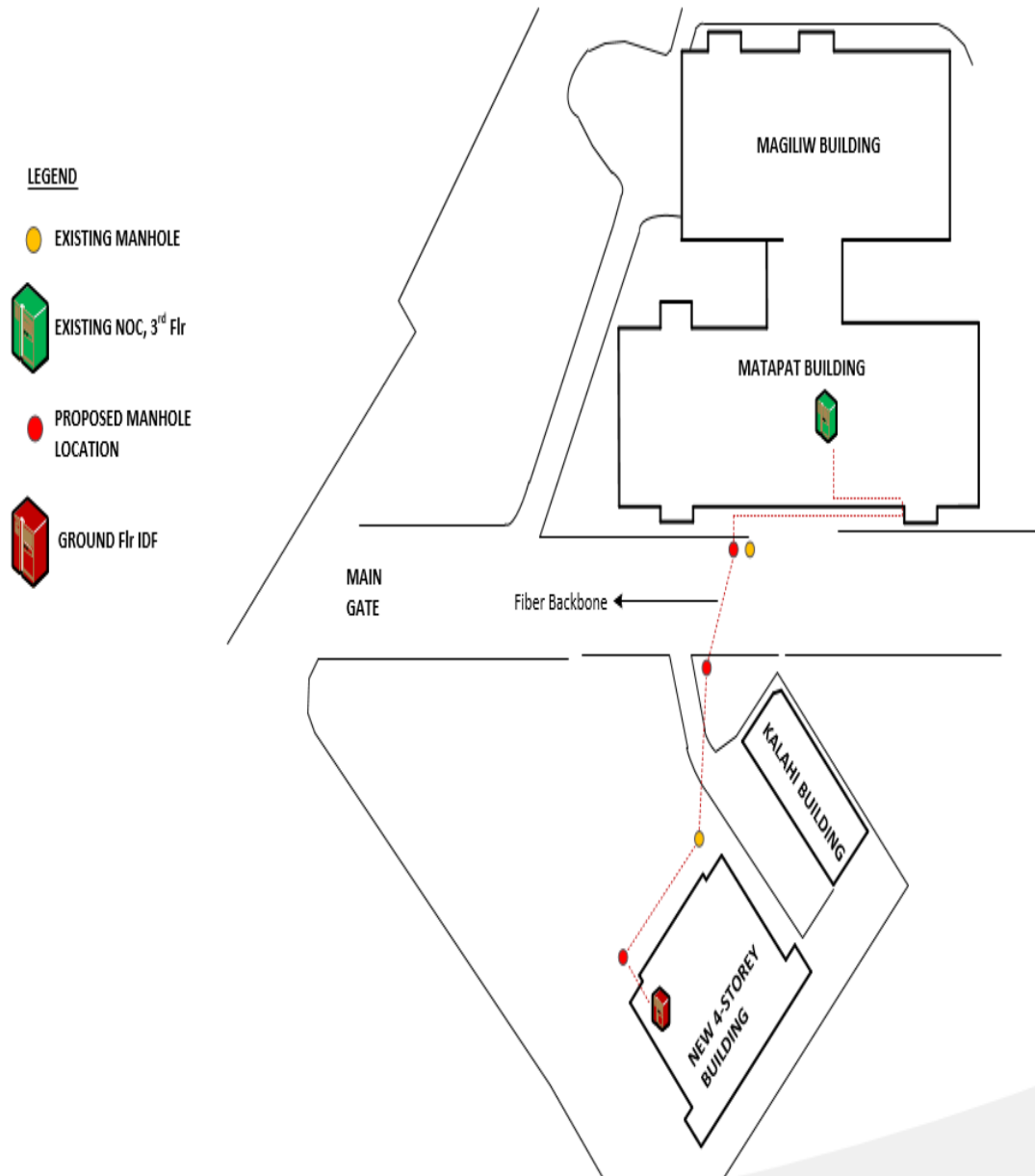

Name of Bidder: \_\_\_\_\_

Name of Authorized Representative: \_\_\_\_\_

Signature of Authorized Representative: \_\_\_\_\_

Date: \_\_\_\_\_

## ***Section VIII. Bidding Forms***



## TABLE OF CONTENTS

<b>BID FORM .....</b>	<b>89</b>
<b>PRICE PROPOSAL FORM.....</b>	<b>93</b>
<b>BID SECURING DECLARATION .....</b>	<b>94</b>
<b>CONTRACT AGREEMENT FORM.....</b>	<b>96</b>
<b>OMNIBUS SWORN STATEMENT.....</b>	<b>99</b>
<b>BANK GUARANTEE FORM FOR ADVANCE PAYMENT .....</b>	<b>102</b>
<b>CERTIFICATION FROM INSURANCE COMMISSION .....</b>	<b>103</b>
<b>STATEMENT OF ALL ON-GOING GOVERNMENT AND PRIVATE CONTRACTS, INCLUDING CONTRACTS AWARDED BUT NOT YET STARTED, WHETHER SIMILAR OR NOT SIMILAR IN NATURE AND COMPLEXITY TO THE CONTRACT TO BE BID.....</b>	<b>104</b>
<b>STATEMENT OF SINGLE LARGEST COMPLETED CONTRACT (SLCC) SIMILAR TO THE CONTRACT TO BE BID.....</b>	<b>105</b>

## Bid Form

---

Date: \_\_\_\_\_

Invitation to Bid N<sup>o</sup>: GOP/19-DSWD-007

To: *[name and address of Procuring Entity]*

Gentlemen and/or Ladies:

Having examined the Bidding Documents including Bid Bulletin Numbers *[insert numbers]*, the receipt of which is hereby duly acknowledged, we, the undersigned, offer to *[supply/deliver/perform] [description of the Goods]* in conformity with the said Bidding Documents for the sum of *[total Bid amount in words and figures]* or such other sums as may be ascertained in accordance with the Schedule of Prices attached herewith and made part of this Bid.

We undertake, if our Bid is accepted, to deliver the goods in accordance with the delivery schedule specified in the Schedule of Requirements.

If our Bid is accepted, we undertake to provide a performance security in the form, amounts, and within the times specified in the Bidding Documents.

We agree to abide by this Bid for the Bid Validity Period specified in **BDS** provision for **ITB** Clause 18.2 and it shall remain binding upon us and may be accepted at any time before the expiration of that period.

Until a formal Contract is prepared and executed, this Bid, together with your written acceptance thereof and your Notice of Award, shall be binding upon us.

We understand that you are not bound to accept the Lowest Calculated Bid or any Bid you may receive.

We certify/confirm that we comply with the eligibility requirements as per **ITB** Clause 5 of the Bidding Documents.

We likewise certify/confirm that the undersigned, *[for sole proprietorships, insert: as the owner and sole proprietor or authorized representative of Name of Bidder, has the full power and authority to participate, submit the bid, and to sign and execute the ensuing contract, on the latter's behalf for the Name of Project of the Name of the Procuring Entity]* *[for partnerships, corporations, cooperatives, or joint ventures, insert: is granted full power and authority by the Name of Bidder, to participate, submit the bid, and to sign and execute the ensuing contract on the latter's behalf for Name of Project of the Name of the Procuring Entity].*

We acknowledge that failure to sign each and every page of this Bid Form, including the attached Schedule of Prices, shall be a ground for the rejection of our bid.

Dated this \_\_\_\_\_ day of \_\_\_\_\_ 20\_\_\_\_.

\_\_\_\_\_  
*[signature]*

\_\_\_\_\_  
*[in the capacity of]*

Duly authorized to sign Bid for and on behalf of \_\_\_\_\_

**For Goods Offered From Abroad**

Name of Bidder \_\_\_\_\_, Invitation to Bid Number \_\_\_\_.  
 Page \_\_\_\_\_ of \_\_\_\_.

1	2	3	4	5	6	7	8	9
Item	Description	Country of origin	Quantity	Unit price CIF port of entry (specify port) or CIP named place (specify border point or place of destination)	Total CIF or CIP price per item (col. 4 x 5)	Unit Price Delivered Duty Unpaid (DDU)	Unit price Delivered Duty Paid (DDP)	Total Price delivered DDP (col 4 x 8)

\_\_\_\_\_  
*[signature]*

\_\_\_\_\_  
*[in the capacity of]*

Duly authorized to sign Bid for and on behalf of \_\_\_\_\_

**For Goods Offered From Within the Philippines**

Name of Bidder \_\_\_\_\_, Invitation to Bid Number \_\_.  
 Page \_\_\_\_\_ of \_\_\_\_.

1	2	3	4	5	6	7	8	9	10
Item	Description	Country of origin	Quantity	Unit price EXW per item	Transportation and Insurance and all other costs incidental to delivery, per item	Sales and other taxes payable if Contract is awarded, per item	Cost of Incidental Services, if applicable, per item	Total Price, per unit (col 5+6+7+8)	Total Price delivered Final Destination (col 9) x (col 4)

\_\_\_\_\_  
*[signature]*

\_\_\_\_\_  
*[in the capacity of]*

Duly authorized to sign Bid for and on behalf of \_\_\_\_\_

## Price Proposal Form

---

Date: \_\_\_\_\_

Invitation to Bid N<sup>o</sup>: GOP/19-DSWD-007

### Subscription of Local Area Network Services for DSWD Central Office New Building

<b>Lot No.</b>	<b>Particulars</b>	<b>Quantity</b>	<b>Unit Price</b> <i>(in Phil Peso)</i>	<b>Total Price</b> <i>(in Phil Peso)</i>
1	Subscription of Local Area Network Services for DSWD Central Office New Building	One (1) Lot		
<b>TOTAL CONTRACT PRICE</b>				

NOTE: In case of discrepancy between unit price and total price, the unit price will prevail.  
Total Contract Price is inclusive of all applicable taxes.

Name of Bidder: \_\_\_\_\_

Name of Authorized Representative: \_\_\_\_\_

Signature of Authorized Representative: \_\_\_\_\_

Date: \_\_\_\_\_

## BID SECURING DECLARATION FORM

---

**REPUBLIC OF THE PHILIPPINES)**  
**CITY OF \_\_\_\_\_) S.S.**

X-----X

### **BID SECURING DECLARATION** **Invitation to Bid: [Insert Reference number]**

To: *[Insert name and address of the Procuring Entity]*

I/We, the undersigned, declare that:

1. I/We understand that, according to your conditions, bids must be supported by a Bid Security, which may be in the form of a Bid-Securing Declaration.
2. I/We accept that: (a) I/we will be automatically disqualified from bidding for any contract with any procuring entity for a period of two (2) years upon receipt of your Blacklisting order; and, (b) I/we will pay the applicable fine provided under Section 6 of the Guidelines on the Use of Bid Securing Declaration, within fifteen (15) days from receipt of the written demand by the procuring entity for the commission of acts resulting to the enforcement of the bid securing declaration under Sections 23.1(b), 34.2, 40.1 and 69.1, except 69.1(f), of the IRR of RA 9184; without prejudice to other legal action the government may undertake.
3. I/We understand that this Bid Securing Declaration shall cease to be valid on the following circumstances:
  - (a) Upon expiration of the bid validity period, or any extension thereof pursuant to your request;
  - (b) I am/we are declared ineligible or post-disqualified upon receipt of your notice to such effect, and (i) I/we failed to timely file a request for reconsideration or (ii) I/we filed a waiver to avail of said right;
  - (c) I am/we are declared the bidder with the Lowest Calculated Responsive Bid, and I/we have furnished the performance security and signed the Contract.

IN WITNESS WHEREOF, I/We have hereunto set my/our hand/s this \_\_\_\_ day of [month] [year] at [place of execution].

[Insert NAME OF BIDDER'S AUTHORIZED REPRESENTATIVE]  
[Insert Signatory's Legal Capacity]  
Affiant

**SUBSCRIBED AND SWORN** to before me this \_\_\_\_ day of [month] [year] at [place of execution], Philippines. Affiant/s is/are personally known to me and was/were identified by me through competent evidence of identity as defined in the 2004 Rules on Notarial Practice (A.M. No. 02-8-13-SC). Affiant/s exhibited to me his/her [insert type of government identification card used], with his/her photograph and signature appearing thereon, with no. \_\_\_\_\_ and his/her Community Tax Certificate No. \_\_\_\_\_ issued on \_\_\_\_ at \_\_\_\_\_.

Witness my hand and seal this \_\_\_\_ day of [month] [year].

**NAME OF NOTARY PUBLIC**

Serial No. of Commission \_\_\_\_\_

Notary Public for \_\_\_\_\_ until \_\_\_\_\_

Roll of Attorneys No. \_\_\_\_\_

PTR No. \_\_\_\_\_ [date issued], [place issued]

IBP No. \_\_\_\_\_ [date issued], [place issued]

Doc. No. \_\_\_\_\_

Page No. \_\_\_\_\_

Book No. \_\_\_\_\_

Series of \_\_\_\_\_



## Contract Agreement Form

---

### CONTRACT

KNOW ALL MEN BY THESE PRESENTS:

The **DEPARTMENT OF SOCIAL WELFARE AND DEVELOPMENT**, a government agency with principal office address at IBP Road, Batasan Pambansa Complex, Constitution Hills, Quezon City, Metro Manila, represented by [*Secretary/ ExeCom/ ManCom*] (hereinafter called the “PROCURING ENTITY”);

-and-

[*Name of Supplier*], a [sole proprietorship/corporation] with principal business address at [*Complete address of Supplier*] represented herein by its Authorized Representative [*Name of Authorized Representative*] (hereinafter called the “SUPPLIER”);

WHEREAS, the Procuring Entity through Competitive Bidding invited Bids for certain goods and ancillary services, specifically, [*brief description of goods and services (ITB No.)*], where [no. of bidder(s)] bidder(s) submitted its/their bid proposal(s), and after deliberation of the Bids and Awards Committee (BAC), has accepted the Bid of the Supplier being the Single/Lowest Calculated and Responsive Bidder (S/LCRB), with the total contract price of [*contract price in words and figures*] (hereinafter called “the Contract Price”).

NOW THIS AGREEMENT WITNESSETH AS FOLLOWS:

1. In this Agreement words and expressions shall have the same meanings as are respectively assigned to them in the Conditions of Contract referred to.
2. The following documents shall be deemed to form and be read and construed as part of this Agreement, namely:
  - (a) the Bid Form and the Price Proposal Form/Schedule submitted by the Bidder;
  - (b) the Schedule of Requirements;
  - (c) the Technical Specifications;
  - (d) the General Conditions of Contract;
  - (e) the Special Conditions of Contract;
  - (f) the Supplemental/Bid Bulletins (if applicable);
  - (g) the Joint Venture Agreement (if applicable); and
  - (g) the Entity’s Notification of Award;
3. In consideration of the payments to be made by the Entity to the Supplier as hereinafter mentioned, the Supplier hereby covenants with the Entity to provide the goods and services and to remedy defects therein in conformity in all respects with the provisions of the Contract.

4. The Entity hereby covenants to pay the Supplier in consideration of the provision of the goods and services and the remedying of defects therein, the Contract Price or such other sum as may become payable under the provisions of the contract at the time and in the manner prescribed by the contract.

IN WITNESS whereof the parties signed this Contract in Quezon City, Philippines on the \_\_\_\_ day of \_\_\_\_\_ 20\_\_.

FOR THE PROCURING ENTITY

FOR THE SUPPLIER

By

\_\_\_\_\_

\_\_\_\_\_

Authorized Representative

-Witnesses-

\_\_\_\_\_

\_\_\_\_\_

Certified Funds Available:

\_\_\_\_\_  
Chief, Accounting Division (AD)

Republic of the Philippines)  
\_\_\_\_\_ ) S.S.

BEFORE ME, a Notary Public for and in Quezon City, on this \_\_\_\_ day of \_\_\_\_\_  
20\_\_ personally appeared the following with their respective proof of Identification;

\_\_\_\_\_ ID Type/No. : \_\_\_\_\_  
Place Issued : \_\_\_\_\_  
Date Issued : \_\_\_\_\_

\_\_\_\_\_ ID Type/No. : \_\_\_\_\_  
Place Issued : \_\_\_\_\_  
Date Issued : \_\_\_\_\_

Both known to me to be the same people who executed the foregoing instrument and *who* acknowledge to me that the same is their own free will and voluntary act and deed.

This agreement consisting of three (3) pages signed by the parties and their instrumental witnesses in all pages refer to an AGREEMENT for the *[brief description of goods and services]* (*[ITB No.]*) by the SUPPLIER.

WITNESS MY HAND AND NOTARIAL SEAL on the date and place first above written.

NOTARY PUBLIC

Doc. No. \_\_\_\_\_  
Page No. \_\_\_\_\_  
Book No. \_\_\_\_\_  
Series of 20\_\_\_\_\_

## Omnibus Sworn Statement

---

REPUBLIC OF THE PHILIPPINES )  
CITY/MUNICIPALITY OF \_\_\_\_\_ ) S.S.

### AFFIDAVIT

I, *[Name of Affiant]*, of legal age, *[Civil Status]*, *[Nationality]*, and residing at *[Address of Affiant]*, after having been duly sworn in accordance with law, do hereby depose and state that:

1. **Select one, delete the other:**

*If a sole proprietorship:* I am the sole proprietor or authorized representative of *[Name of Bidder]* with office address at *[address of Bidder]*;

*If a partnership, corporation, cooperative, or joint venture:* I am the duly authorized and designated representative of *[Name of Bidder]* with office address at *[address of Bidder]*;

2. **Select one, delete the other:**

*If a sole proprietorship:* As the owner and sole proprietor, or authorized representative of *[Name of Bidder]*, I have full power and authority to do, execute and perform any and all acts necessary to participate, submit the bid, and to sign and execute the ensuing contract for *[Name of the Project]* of the *[Name of the Procuring Entity]*, as shown in the attached duly notarized *Special Power of Attorney*;

*If a partnership, corporation, cooperative, or joint venture:* I am granted full power and authority to do, execute and perform any and all acts necessary to participate, submit the bid, and to sign and execute the ensuing contract for *[Name of the Project]* of the *[Name of the Procuring Entity]*, as shown in the attached *[state title of attached document showing proof of authorization (e.g., duly notarized Secretary's Certificate, Board/Partnership Resolution, or Special Power of Attorney, whichever is applicable)]*;

3. *[Name of Bidder]* is not "blacklisted" or barred from bidding by the Government of the Philippines or any of its agencies, offices, corporations, or Local Government Units, foreign government/foreign or international financing institution whose blacklisting rules have been recognized by the Government Procurement Policy Board;
4. Each of the documents submitted in satisfaction of the bidding requirements is an authentic copy of the original, complete, and all statements and information provided therein are true and correct;
5. *[Name of Bidder]* is authorizing the Head of the Procuring Entity or its duly authorized representative(s) to verify all the documents submitted;

6. **Select one, delete the rest:**

*If a sole proprietorship:* The owner or sole proprietor is not related to the Head of the Procuring Entity, members of the Bids and Awards Committee (BAC), the Technical Working Group, and the BAC Secretariat, the head of the Project Management Office or the end-user unit, and the project consultants by consanguinity or affinity up to the third civil degree;

*If a partnership or cooperative:* None of the officers and members of [Name of Bidder] is related to the Head of the Procuring Entity, members of the Bids and Awards Committee (BAC), the Technical Working Group, and the BAC Secretariat, the head of the Project Management Office or the end-user unit, and the project consultants by consanguinity or affinity up to the third civil degree;

*If a corporation or joint venture:* None of the officers, directors, and controlling stockholders of [Name of Bidder] is related to the Head of the Procuring Entity, members of the Bids and Awards Committee (BAC), the Technical Working Group, and the BAC Secretariat, the head of the Project Management Office or the end-user unit, and the project consultants by consanguinity or affinity up to the third civil degree;

7. [Name of Bidder] complies with existing labor laws and standards; and
8. [Name of Bidder] is aware of and has undertaken the following responsibilities as a Bidder:
- a) Carefully examine all of the Bidding Documents;
  - b) Acknowledge all conditions, local or otherwise, affecting the implementation of the Contract;
  - c) Made an estimate of the facilities available and needed for the contract to be bid, if any; and
  - d) Inquire or secure Supplemental/Bid Bulletin(s) issued for the [Name of the Project].
9. [Name of Bidder] did not give or pay directly or indirectly, any commission, amount, fee, or any form of consideration, pecuniary or otherwise, to any person or official, personnel or representative of the government in relation to any procurement project or activity.

IN WITNESS WHEREOF, I have hereunto set my hand this \_\_\_ day of \_\_\_, 20\_\_ at \_\_\_\_\_, Philippines.

\_\_\_\_\_  
Bidder's Representative/Authorized Signatory

**SUBSCRIBED AND SWORN** to before me this \_\_\_\_ day of [month] [year] at [place of execution], Philippines. Affiant/s is/are personally known to me and was/were identified by me through competent evidence of identity as defined in the 2004 Rules on Notarial Practice (A.M. No. 02-8-13-SC). Affiant/s exhibited to me his/her [insert type of government identification card used], with his/her photograph and signature appearing thereon, with no. \_\_\_\_\_ and his/her Community Tax Certificate No. \_\_\_\_\_ issued on \_\_\_\_ at \_\_\_\_\_.

Witness my hand and seal this \_\_\_\_ day of [month] [year].

**NAME OF NOTARY PUBLIC**

Serial No. of Commission \_\_\_\_\_

Notary Public for \_\_\_\_\_ until \_\_\_\_\_

Roll of Attorneys No. \_\_\_\_\_

PTR No. \_\_\_\_\_ [date issued], [place issued]

IBP No. \_\_\_\_\_ [date issued], [place issued]

Doc. No. \_\_\_\_\_

Page No. \_\_\_\_\_

Book No. \_\_\_\_\_

Series of \_\_\_\_\_

\* This form will not apply for WB funded projects.

## Bank Guarantee Form for Advance Payment

---

To: *[name and address of PROCURING ENTITY]*  
*[name of Contract]*

Gentlemen and/or Ladies:

In accordance with the payment provision included in the Special Conditions of Contract, which amends Clause 10 of the General Conditions of Contract to provide for advance payment, *[name and address of Supplier]* (hereinafter called the "Supplier") shall deposit with the PROCURING ENTITY a bank guarantee to guarantee its proper and faithful performance under the said Clause of the Contract in an amount of *[amount of guarantee in figures and words]*.

We, the *[bank or financial institution]*, as instructed by the Supplier, agree unconditionally and irrevocably to guarantee as primary obligator and not as surety merely, the payment to the PROCURING ENTITY on its first demand without whatsoever right of objection on our part and without its first claim to the Supplier, in the amount not exceeding *[amount of guarantee in figures and words]*.

We further agree that no change or addition to or other modification of the terms of the Contract to be performed thereunder or of any of the Contract documents which may be made between the PROCURING ENTITY and the Supplier, shall in any way release us from any liability under this guarantee, and we hereby waive notice of any such change, addition, or modification.

This guarantee shall remain valid and in full effect from the date of the advance payment received by the Supplier under the Contract until *[date]*.

Yours truly,

Signature and seal of the Guarantors

---

*[name of bank or financial institution]*

---

*[address]*

---

*[date]*

## Certification from Insurance Commission

---

**NOTE:** Use this template for the required “Certification from the Insurance Commission”, which shall accompany surety bonds issued for purposes of Bid Security and Performance Security.

### [Insurance Commission Letterhead]

#### CERTIFICATION

This is to certify that [insert Name of Insurance Company] is an authorized insurance company and licensed to transact general insurance business in the Philippines for such lines as Fire, Marine, Casualty and Surety under [insert Certificate of Authority Number ] effective [insert date of period of effectivity], unless sooner revoked or suspended for cause.

It is certified, moreover, that [insert Name of Insurance Company] is likewise authorized under Administrative Order No. 30 to underwrite and issue Performance Bonds, Bidder’s Bonds, and Surety Bonds, callable on demand in favor of the various agencies and instrumentalities of the government pursuant to the Revised Implementing Rules of RA.9184. It is further certified that [insert Name of Insurance Company] issued a surety bond under [insert Bond No.] to [insert Name of Service Provider or Supplier] in favor of **Department of Social Welfare and Development** in the amount of [insert amount] for the [insert Name of the Project].

This certification is issued upon the request of [insert Name of the Authorized Representative] of [insert Name of Insurance Company], pursuant to Section 39.2( c ) of the Revised Implementing Rules and Regulations of RA9184.

Issued on the [insert date] in [insert Place].

For the Insurance Commissioner  
[insert name of Authorized Representative]  
[insert Position and Office]  
Paid under[insert Official Receipt No.]



**Statement of All On-Going Government and Private Contracts, Including Contracts Awarded but Not Yet Started, Whether Similar or Not Similar in Nature and Complexity to the Contract to be Bid**

---

Business Name: \_\_\_\_\_

Business Address: \_\_\_\_\_

**A. Government**

Nature of Contract (Project Title)	a. Owner's Name	Project Cost	Bidder's Role		a. Date Awarded	% of Accomplishment		Value of Outstanding Works (Undelivered Portion)
	b. Address		Description	%	b. Date Started	Planned	Actual	
	c. Contact Nos.				c. Date Completed			
1.	a.				a.			
	b.				b.			
	c.				c.			
2.	a.				a.			
	b.				b.			
	c.				c.			

**B. Private**

Nature of Contract (Project Title)	a. Owner's Name	Project Cost	Bidder's Role		a. Date Awarded	% of Accomplishment		Value of Outstanding Works (Undelivered Portion)
	b. Address		Description	%	b. Date Started	Planned	Actual	
	c. Contact Nos.				c. Date Completed			
1.	a.				a.			
	b.				b.			
	c.				c.			
2.	a.				a.			
	b.				b.			
	c.				c.			

*Note: The following documents must be available upon request of the Bids and Award Committee (BAC) or designated Technical Working Group (TWG) during Post-Qualification to support this statement: (a) Contract or Purchase Order, (b) Official Receipt(s) or Sales Invoice or (c) User's Certificate of Acceptance/Completion*

Name of Bidder: \_\_\_\_\_

Name of Authorized Representative: \_\_\_\_\_

Signature of Authorized Representative: \_\_\_\_\_

Date: \_\_\_\_\_

**Statement of Single Largest Completed Contract (SLCC)<sup>5</sup> Similar to the Contract to be Bid**

Business Name: \_\_\_\_\_

Business Address: \_\_\_\_\_

Nature of Contract (Project Title)	a. Owner's Name	Project Cost	Bidder's Role		a. Date Awarded
	b. Address		Description	%	b. Date Started
	c. Contact Nos.				c. Date Completed
	a.				a.
	b.				b.
	c.				c.

Note: *The following documents must be attached to support this statement: (a) Official Receipt(s) or Sales Invoice or (b) User's Certificate of Acceptance/Completion*

Name of Bidder: \_\_\_\_\_

Name of Authorized Representative: \_\_\_\_\_

Signature of Authorized Representative: \_\_\_\_\_

Date: \_\_\_\_\_

<sup>5</sup> The Bidder must have completed, within the period specified in the Invitation to Bid and ITB Clause 12.1(a)(ii), a single contract that is similar to the project to be bid, equivalent to a percentage (%) of the ABC specified in ITB Clause 5.4.

